

PowerLogic™ ION9000 series

User manual

08/2018

7EN02-0390-00



Legal Information

The Schneider Electric brand and any registered trademarks of Schneider Electric Industries SAS referred to in this guide are the sole property of Schneider Electric SA and its subsidiaries. They may not be used for any purpose without the owner's permission, given in writing. This guide and its content are protected, within the meaning of the French intellectual property code (Code de la propriété intellectuelle français, referred to hereafter as "the Code"), under the laws of copyright covering texts, drawings and models, as well as by trademark law. You agree not to reproduce, other than for your own personal, noncommercial use as defined in the Code, all or part of this guide on any medium whatsoever without Schneider Electric's permission, given in writing. You also agree not to establish any hypertext links to this guide or its content. Schneider Electric does not grant any right or license for the personal and noncommercial use of the guide or its content, except for a non-exclusive license to consult it on an "as is" basis, at your own risk. All other rights are reserved.

Electrical equipment should be installed, operated, serviced, and maintained only by qualified personnel. No responsibility is assumed by Schneider Electric for any consequences arising out of the use of this material.

As standards, specifications, and designs change from time to time, please ask for confirmation of the information given in this publication.

Safety information

Important information

Read these instructions carefully and look at the equipment to become familiar with the device before trying to install, operate, service, or maintain it. The following special messages may appear throughout this manual or on the equipment to warn of potential hazards or to call attention to information that clarifies or simplifies a procedure.



The addition of either symbol to a “Danger” or “Warning” safety label indicates that an electrical hazard exists which will result in personal injury if the instructions are not followed.



This is the safety alert symbol. It is used to alert you to potential personal injury hazards. Obey all safety messages that accompany this symbol to avoid possible injury or death.

⚠ DANGER

DANGER indicates a hazardous situation which, if not avoided, **will result in** death or serious injury.

Failure to follow these instructions will result in death or serious injury.

⚠ WARNING

WARNING indicates a hazardous situation which, if not avoided, **could result in** death or serious injury.

⚠ CAUTION

CAUTION indicates a hazardous situation which, if not avoided, **could result in** minor or moderate injury.

NOTICE

NOTICE is used to address practices not related to physical injury.

Please note

Electrical equipment should be installed, operated, serviced and maintained only by qualified personnel. No responsibility is assumed by Schneider Electric for any consequences arising out of the use of this material. A qualified person is one who has skills and knowledge related to the construction, installation, and operation of electrical equipment and has received safety training to recognize and avoid the hazards involved.

Notices

FCC

This equipment has been tested and found to comply with the limits for a Class B digital device, pursuant to part 15 of the FCC rules. These limits are designed to provide reasonable protection against harmful interference in a residential installation. This equipment generates, uses, and can radiate radio frequency energy and, if not installed and used in accordance with the instructions, may cause harmful interference to radio communications. However, there is no guarantee that the interference will not occur in a particular installation. If this equipment does cause harmful interference to radio or television reception, which can be determined by turning the equipment off and on, the user is encouraged to try to correct the interference by one or more of the following measures:

- Reorient or relocate the receiving antenna.
- Increase the separation between the equipment and receiver.
- Connect the equipment to an outlet on a circuit different from that to which the receiver is connected.
- Consult the dealer or an experienced radio/TV technician for help.

The user is cautioned that any changes or modifications not expressly approved by Schneider Electric could void the user's authority to operate the equipment.

This digital apparatus complies with CAN ICES-3 (B) /NMB-3(B).

About this manual

This manual discusses features of the PowerLogic™ ION9000 series power meter and provides configuration instructions.

Throughout the manual, the term “meter” refers to all models of the ION9000. All differences between the models, such as a feature specific to one model, are indicated with the appropriate model number or description.

This manual assumes you have an understanding of power metering and are familiar with the equipment and power system in which your meter is installed.

This manual does not provide configuration information for advanced features where an expert user would perform advanced configuration. It also does not include instructions on how to incorporate meter data or perform meter configuration using energy management systems or software, other than ION Setup. ION Setup is a free configuration tool available for download from www.schneider-electric.com.

Please contact your local Schneider Electric representative to learn what additional training opportunities are available regarding the ION9000 meter.

Make sure you are using the most up-to-date version of your meter's firmware in order to access the latest features.

The most up-to-date documentation about your meter is available for download from www.schneider-electric.com.



Related documents

Document	Number
ION9000 online document portal	https://www.productinfo.schneider-electric.com/portals/ui/ion9000/
PowerLogic™ ION9000 series installation sheet	NVE78642
ION Reference	7EN02-0290
ION device template reference	—
PowerLogic™ ION9000 technical datasheet	PLSED310106EN

Table of Contents

Safety precautions	15
Meter overview	16
ION9000 series	16
Your meter in an energy management system	16
Communications	17
Supported protocols	17
Meter configuration	18
ION Setup device configuration tool	18
Data display	18
Built-in webpages and web server feature	18
Localization	18
Display	18
Notification	18
Active and historical alarms	18
Email messaging feature	19
Meter models and accessories	19
Installation and commissioning	20
Installation	20
Residual current measurement	20
Functional ground	21
Removing the display from back-to-back mounting adapter	21
Removing the meter from back-to-back mounting adapter	23
Option modules	24
Maximum number of option modules	25
Commissioning	25
Factory default settings	25
Commissioning using ION Setup	26
Configure basic metering parameters	26
Using the phasor viewer	27
Basic setup using the webpages or display	28
Communications	29
Communications overview	29
Ethernet communications	29
Ethernet communications connections	29
Protocols, ports and connections	30
Self-discovery over Ethernet	31
Ethernet configuration	32
DHCP	39
Meter domain name	40
Network protocol control	40
Serial communications	42
RS-485 wiring	42
RS-485 configuration	43
Disabling serial communications ports	46
ION	47
Modbus	47
Modbus best practices for Ethernet	48

Modbus best practices for serial	48
Your meter as a Modbus master	49
Your meter as a Modbus slave	50
Supported Modbus features	53
Modbus implementation	54
Modbus map	55
Ethernet gateway	57
EtherGate	57
Modbus Ethernet gateway	59
Creating an Ethernet gateway site using ION Setup	60
HTTP	61
Changing HTTP protocol using ION Setup	61
Secure website indicator	62
Default SSL certificate and webpages security	62
Uploading a custom SSL certificate	62
Generating a new self-signed SSL certificate	63
Deleting a custom SSL certificate	63
FTP	63
Accessing your meter's FTP server	63
FTP memory allocation	63
FTP file structure and permissions	64
FTP filename requirements	64
Simple Network Management Protocol (SNMP)	64
The meter in an SNMP system	65
SNMP trapping	65
SNMP implementation	67
Default SNMP mapping	68
IEC 61850	69
IEC 61850 implementation	69
Configuring digital outputs for IEC 61850 control using ION Setup	71
DNP	71
DNP supported features and default implementation	72
DLMS/COSEM	72
Inputs / outputs	73
I/O overview	73
Input/output ION modules	73
Input/output ION modules, ports and labels	73
I/O option modules	74
I/O option module data viewing	75
Option I/O modules configuration	75
Analog inputs	76
Analog input applications	76
Analog input voltage and current mode	76
Analog input behavior	76
Analog input zero scale and full scale values	77
Analog outputs	78
Analog output applications	78
Analog output behavior	78
Analog output zero scale and full scale values	78
Digital inputs	79

Digital input applications	79
IRIG-B time synchronization	80
WAGES monitoring	82
WAGES example	82
Input metering	83
Digital outputs	85
Digital output applications	85
Energy pulsing	87
Default energy pulsing LED sources	87
Configuring LED energy pulsing using ION Setup	88
Webpages	90
Webpage interface	90
Default meter webpages	90
Accessing webpages for data viewing and meter configuration	91
Viewing files using your meter's webpages	92
Creating custom webpages for your meter	93
Sample data viewing webpage	94
Display	101
Display overview	101
Revenue lock icon	102
Display icons	103
More screens access	103
Interrupted display data	104
Auto-scaling feature	104
Display screens	104
Display modes	104
Norm mode display menu	105
Alt mode display menu	105
Setup menu	107
Meter setup using your display	108
Creating custom displays using ION Setup	111
Display scaling	112
Remote display troubleshooting icons	112
Security	114
Security overview	114
Security features on your device	114
Enable/disable communication ports	114
Network port control	114
Revenue and billing security features	115
Event logging	115
Syslog	115
Advanced security access using the display	115
HTTPS	115
NERC CIP	116
Security recommendations and best practices	116
Standard and advanced security features	117
Security configuration process	117
Communications protocol lockout overview	118
Standard security password setup	119
Advanced security password setup	119

Advanced security username and password through the display	120
Changing your meter password using the display	120
Configuring standard security using ION Setup	120
Configuring users and passwords using ION Setup (advanced security only)	122
Loading a security configuration file using ION Setup	123
Alarms and alerts	124
Alarms overview	124
Alarm types	124
Relative setpoint	126
Transient alarms	127
Alarm event priorities	127
Alarm indicators	127
Default alarms	128
Alarm information	129
Viewing and acknowledging alarms using the display	129
Alarm configuration	129
Sag/swell overview	132
Configuring transient alarms using ION Setup	133
Alerting	134
Setpoint learning overview	135
Learning installation mode and learning duration	135
Implementing standard alarm setpoint learning using ION Setup	136
Implementing transient learning using ION Setup	138
Power quality	140
Power quality overview	140
Considerations for power quality configuration using ION Setup	140
Power quality logging	141
Sag/swell overview	141
Transient overview	143
Configuring Advanced PQ using ION Setup	144
Rapid Voltage Change overview	147
Harmonics overview	147
Viewing harmonics information using the display	147
Voltage crest factor	147
Current crest factor	148
K-factor	148
Harmonic content calculations	148
THD% calculations	148
thd and TDD	149
Phasors	149
Power quality standards compliance	149
Disturbance direction detection overview	150
COMTRADE	151
COMTRADE implementation overview	151
Waveforms on your meter's webpages	152
Burst data logging	154
Data recorder burst data	154
Waveform capture	155
Standard waveform capture	155
Delayed waveform capture	156

Extended waveform capture	157
Logging	159
Logging overview	159
Default data logging configuration	159
Configuring data logging using ION Setup	165
Waveform recording overview	165
Default waveform recording configuration	166
Event log overview	168
Default event log configuration	168
Syslog overview	169
Configuring Syslog network settings using ION Setup	170
Syslog severity to event log priority mapping	170
Advanced log setup and memory optimization	170
Viewing log configuration and memory usage information	170
Log depth configuration	171
Log interval configuration.....	171
Log mode configuration	171
Log buffer configuration.....	172
Changing log interval and depth settings using ION Setup	174
Time and timekeeping	176
Time overview	176
Internal clock temperature compensation	176
Time synchronization	176
Supported time synchronization sources.....	176
Clock source	177
Clock source time quality flag.....	178
PTP system setting recommendations	178
Configuring time information using ION Setup.....	179
Configuring time information using the display	181
Measurements	182
Energy.....	182
Demand.....	182
Instantaneous measurements	182
Harmonics	182
Min/max recording	183
Power quality	183
Power and power factor	183
Power demand	185
Incremental energy.....	186
Conditional energy.....	188
Trending and forecasting overview.....	189
Resets	190
Meter resets	190
Option modules reset.....	190
Available resets	190
Performing meter resets using ION Setup.....	191
Performing meter resets using the meter webpages	192
Performing meter resets using the display	192
Maintenance	194
Maintenance overview	194

Firmware and templates	194
Firmware and templates overview	194
Typical workflows	194
Laptop computer upgrade considerations	195
Firmware upgrade considerations	195
Editing accumulated energy values using ION Setup	196
Loading meter firmware using ION Setup	197
Loading webpages using ION Setup	198
Loading webpages using FTP	198
Loading remote display firmware using ION Setup	199
Loading option module firmware using ION Setup	200
Test mode	201
Test mode default screens	201
Putting your meter in test mode using the display	201
Device-specific information	202
Troubleshooting	203
Option module troubleshooting	203
Technical assistance	203
Revenue	204
Revenue metering overview	204
Revenue metering components	204
Revenue firmware security features	204
Protected features and settings	204
Revenue locking	204
Revenue-locking summary	205
Revenue lock switch	205
Revenue lock LED behavior	205
Anti-tamper sealing	206
PT/CT correction	207
Transformer loss compensation	207
Time of use	208
Energy pulsing LED behavior	208
Verifying accuracy	209
Overview of meter accuracy	209
Accuracy test requirements	209
Energy pulsing	210
Verifying accuracy test meter settings	210
Verifying accuracy test	211
Calculate the number of required pulses	212
Percentage error calculation for accuracy verification testing	212
Typical sources of test errors	213
Accuracy verification test points	213
Specifications	214
Specifications overview	214
Mechanical characteristics	214
Electrical characteristics	214
Environmental characteristics	216
LEDs	217
EMC (electromagnetic compatibility)	217
Safety	217

Ethernet communications 218
RS-485 communications 218
Real-time clock 218
Display 218
Option modules 219
Other 220

Safety precautions

Installation, wiring, testing and service must be performed in accordance with all local and national electrical codes.

⚠ DANGER

HAZARD OF ELECTRIC SHOCK, EXPLOSION, OR ARC FLASH

- Apply appropriate personal protective equipment (PPE) and follow safe electrical work practices. See NFPA 70E in the USA, CSA Z462 or applicable local standards.
- Turn off all power supplying this device and the equipment in which it is installed before working on the device or equipment.
- Always use a properly rated voltage sensing device to confirm that all power is off.
- Treat communications and I/O wiring connected to multiple devices as hazardous live until determined otherwise.
- Do not exceed the device's ratings for maximum limits.
- Never short the secondary of a potential/voltage transformer (PT/VT).
- Never open circuit a current transformer (CT).
- Always use grounded external CTs for current inputs.
- Do not use the data from the meter to confirm power is off.
- Replace all devices, doors and covers before turning on power to this equipment.

Failure to follow these instructions will result in death or serious injury.

NOTE: See IEC 60950-1:2005, Annex W for more information on communications and I/O wiring connected to multiple devices.

⚠ WARNING

UNINTENDED OPERATION

Do not use this device for critical control or protection applications where human or equipment safety relies on the operation of the control circuit.

Failure to follow these instructions can result in death, serious injury, or equipment damage.

⚠ WARNING

POTENTIAL COMPROMISE OF SYSTEM AVAILABILITY, INTEGRITY, AND CONFIDENTIALITY

- Change default passwords to help prevent unauthorized access to device settings and information.
- Disable unused ports/services and default accounts, where possible, to minimize pathways for malicious attacks.
- Place networked devices behind multiple layers of cyber defenses (such as firewalls, network segmentation, and network intrusion detection and protection).
- Use cybersecurity best practices (for example: least privilege, separation of duties) to help prevent unauthorized exposure, loss, modification of data and logs, interruption of services, or unintended operation.

Failure to follow these instructions can result in death, serious injury, or equipment damage.

Meter overview

ION9000 series

The PowerLogic™ ION9000 series advanced energy and power quality meter helps meet the needs of your energy management, power management, and cost management applications within your EcoStruxure™ Power architecture.

ION9000 series revenue-accurate meters comply to international metering standards. The meters feature flexible ION programmability that enhances functionality through customization by loading specialized frameworks. You can add optional modules and incorporate mounting accessories into the physical installation to meet a variety of installation and application needs.

Measurement accuracy

Third-party international standards-certified

- Class 0,1S for energy
- Power Quality Instrument - Class A (PQI-A) for all normative IEC 61000-4-30 power quality metrics
- IEC 62053-22, -23, -24 and ANSI C12.20

Power quality

Third-party international standards-certified

- IEC 62586-1, IEC 62586-2, and IEC 61000-4-30
- EN 50160, including flicker monitoring
- IEEE 519

Root cause analysis and sequence-of-events support

- Disturbance Direction Detection
- High-speed RMS data capture with pre and post event records
- Extended waveform capture
- Time quality flag for GPS or PTP time sources
- Time synchronization to 1 ms accuracy

Cybersecurity

- Standard and advanced meter security with multiple user credentials and access levels
- Total control for each communications port and protocol, including protocol lockout
- Secure webpages (HTTPS)
- Support for meter event logging to a remote server (syslog)













Your meter in an energy management system

As a key piece in your energy and power management system, the PowerLogic™ ION9000 series meter provides highly accurate measurements and calculations to enable a variety of energy and power management applications

It performs analysis on collected data, alerts you of potential issues and integrates with a variety of edge control software such as EcoStruxure™ Power SCADA Operation and Power Monitoring Expert. For further analysis, you can also connect

your meter with EcoStruxure™ Power Advisor to enhance the performance and maintenance of power networks.



 Perform basic setup using ION Setup, meter webpages or the display.	 Configure meter to help protect against unauthorized configuration of your meter and access to your meter's data.
 Customize meter functionality using the power of ION.	 Improve energy efficiency and track compliance to green standards.
 Access highly accurate measurements and calculations for a wide variety of power system values.	 Help prolong asset life with proactive network management.
 Use the onboard or expansion I/O for non-critical control, WAGES and input metering, energy pulsing and system monitoring, for example, breaker status.	 Log data in a number of onboard default logs, or customize your meter to log other parameters, and access that information using software or webpages.
 Receive notifications of predefined meter and system events or create custom alarms.	 Time of use and perform cost allocation/tenant billing.
 Track the trends for power system values over time to understand: energy usage patterns, optimize network capacity and forecast future usage.	 Easily access information after basic configuration using: <ul style="list-style-type: none"> • a variety of industry-standard protocols. • the touch-screen display. • EcoStruxure™ Power Monitoring Expert and PowerSCADA Operation software. • meter webpages that can be customized to suit your needs. • the meter's gateway feature to access downstream devices.
 <ul style="list-style-type: none"> • Monitor compliance to a variety of power quality standards using the meter's highly accurate metering. • Use the meter's setpoint learning feature to learn your power system's normal operating values. • Locate disturbances using disturbance direction detection. 	

Communications

Supported protocols

Your meter's fundamental protocol and architecture is ION.

You can integrate the meter into various industry-standard networks. Data that the meter measures can be made available to other devices using Modbus, DNP 3.0, DLMS and SNMP as well as the MV-90 translation system. You can configure the meter to import data from other devices on these networks. Your meter supports the IEC 61850 protocol and COMTRADE waveform data format.

Your meter also supports IPv6, DPWS and RSTP Ethernet protocols.

Meter configuration

ION Setup device configuration tool

ION Setup is a free configuration tool for your meter that allows you to remotely configure your meter's features over Ethernet or serial communications.

- Use the setup screens to guide you through the process of configuring your meter.
- Use the real-time data screens to verify your meter's configuration.
- Use the data screens to view your meter's recorded data.
- Use the charting function to view your meter's recorded waveforms.

You can download ION Setup from www.schneider-electric.com.

See the online ION Setup help, available from www.schneider-electric.com, for instructions on connecting to your meter.

Data display

Built-in webpages and web server feature

Your meter's onboard internal web server and built-in web pages provide quick and easy access to real-time energy, basic power quality information and meter configuration without having to use specialized software.

Localization

The meter can be customized to use different regional settings.

Localization settings determine:

- The language used for the display and webpages
- Time, date and digit formats
- Displayed phase labels (123/ABC)
- IEEE (Institute of Electrical and Electronics Engineers) or IEC (International Electrotechnical Commission) conventions for power, power factor and energy

You can configure your meter's localization settings through the display or using ION Setup.

Display

Use the meter's display to view real-time and historical power quality data, access monitoring tools, receive and acknowledge alarms, and perform basic device configuration.

The touch-screen color display has multiple mounting options to suit your environment and an eight-language interface with external LED indicators for power, alarms, and energy pulsing applications.

Notification

Active and historical alarms

The meter's display shows an alarm icon and the alarm LED flashes if your meter detects an active alarm condition.

Depending on the priority of the alarm, your meter's display also flashes. You can view and acknowledge active alarms and historic alarms and events through the display and software webpages. An active alarm becomes a historic alarm when the alarm condition no longer exists.

Email messaging feature

You can configure your meter to automatically email information such as notification of a high-priority event or a regularly scheduled send of logged data.

Specify the type of event that triggers an email alert, such as a power quality disturbance or interval for logged data. Email messages from your meter are received like any other email message.

Meter models and accessories

Commercial references for the ION9000 series meter and accessories.

Commercial reference	Description
METSEION92030 METSEION92830	ION9000 series meter
METSEION92040 METSEION92840	ION9000 series meter with RD192 remote display
METSERD192	RD192 192 x 192 mm remote display with ION9000 series back-to-back adapter and 1/4 DIN (92 x 92 mm) panel cutout mounting adapter
METSEPM89RD96	PM89RD96 92 x 92 mm remote display with 1/4 DIN (92 x 92 mm) panel cutout mounting adapter
METSEPM89M2600	Digital I/O option module (2 outputs, 6 inputs)
METSEPM89M0024	Analog I/O option module (2 outputs, 4 inputs)
METSE9HWK	ION9000 series replacement hardware connectors and terminal covers
METSE9B2BMA	ION9000 series back-to-back adapter
METSERD192HWK	RD192 replacement hardware kit
METSE9USBK	RD192 replacement USB cover

Refer to your meter's catalog pages, available from www.schneider-electric.com, for updated information on meter types and accessories.

Installation and commissioning

This section supplements the meter installation sheets and provides guidance on commissioning your meter.

- See your device installation sheets for information related to installation.
- See your product catalog pages at Schneider Electric for information about your device, its options and accessories.
- Download updated documentation from www.schneider-electric.com.

For the latest information about your product, or for assistance in advanced features and custom functionality, contact your local Schneider Electric representative.

Installation

Installation, wiring, testing and service must be performed in accordance with all local and national electrical codes.

⚠ DANGER

HAZARD OF ELECTRIC SHOCK, EXPLOSION, OR ARC FLASH

- Apply appropriate personal protective equipment (PPE) and follow safe electrical work practices. See NFPA 70E in the USA, CSA Z462 or applicable local standards.
- Turn off all power supplying this device and the equipment in which it is installed before working on the device or equipment.
- Always use a properly rated voltage sensing device to confirm that all power is off.
- Treat communications and I/O wiring connected to multiple devices as hazardous live until determined otherwise.
- Do not exceed the device's ratings for maximum limits.
- Never short the secondary of a potential/voltage transformer (PT/VT).
- Never open circuit a current transformer (CT).
- Always use grounded external CTs for current inputs.
- Do not use the data from the meter to confirm power is off.
- Replace all devices, doors and covers before turning on power to this equipment.

Failure to follow these instructions will result in death or serious injury.

Residual current measurement

The meter can calculate or measure the residual current, depending on how the inputs are wired.

3 CT wiring

For a 3-phase 3-wire system, the meter calculates residual current for Ground.

For a 3-phase 4-wire system, the meter calculates residual current for Neutral.

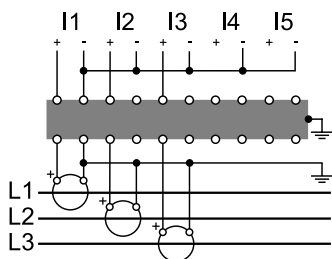

For a 3-phase 3-wire system, the meter measures the residual current for Ground at I4.

For a 3-phase 4-wire system, the meter measures the residual current for Neutral at I4.

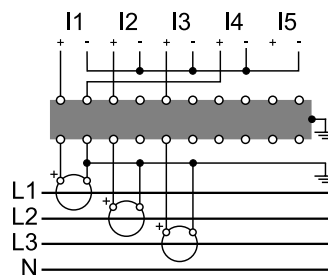

4 CT wiring

For a 3-phase 4-wire system, the meter calculates residual current for Ground.

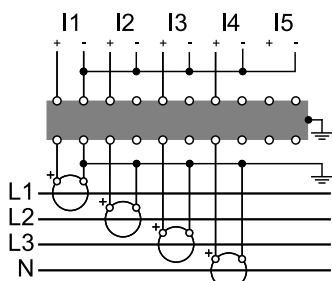

For a 3-phase 4-wire system, the meter measures the residual current for Ground at I5.

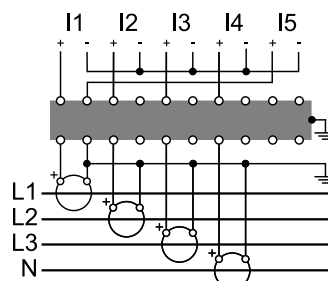

Functional ground

The meter's functional ground terminal must be wired for optimum performance.

Use the supplied ferrite when terminating the functional ground terminal to earth ground. Make sure the ground wire is looped through, around and back through the ferrite as shown.

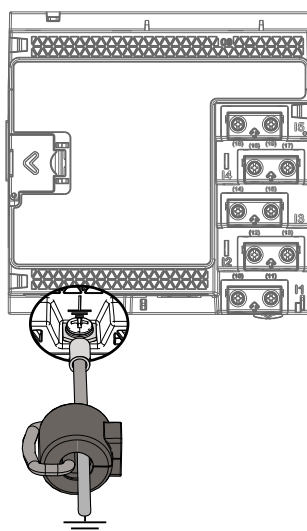

Removing the display from back-to-back mounting adapter

Instructions on how to remove the display, for example, if you want to connect it to another meter.

NOTE: Refer to the display installation sheet QGH42230 for installation instructions.

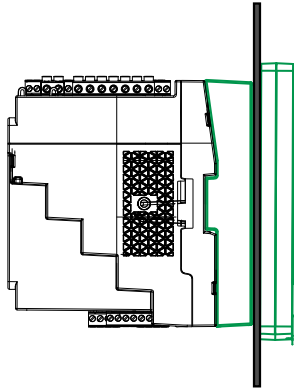

1. Holding the display, turn the tightening wheel with a flat-head screwdriver until it disengages from the display.

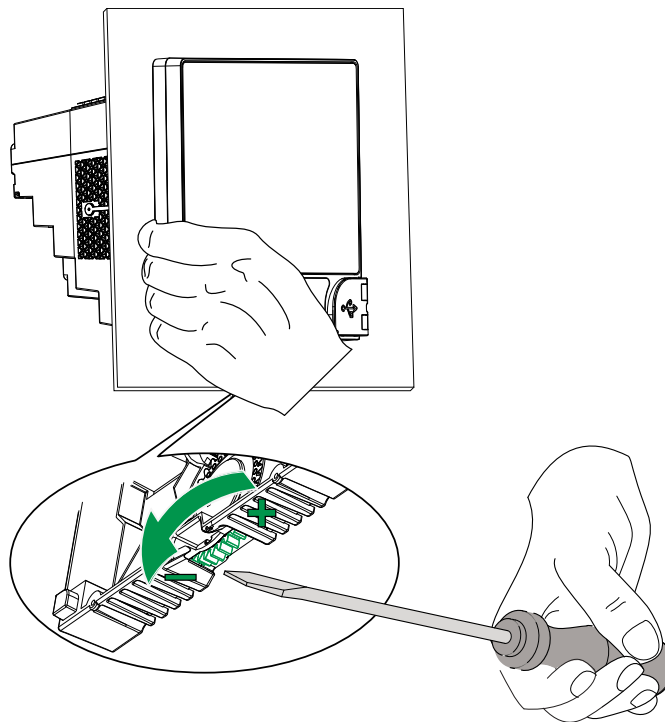

2. Carefully pull the display away, just far enough to access the cable connector on the display.

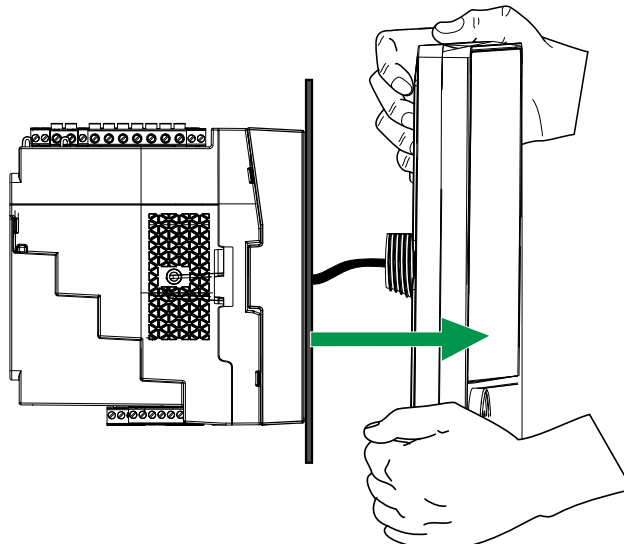

3. Disconnect the display cable.

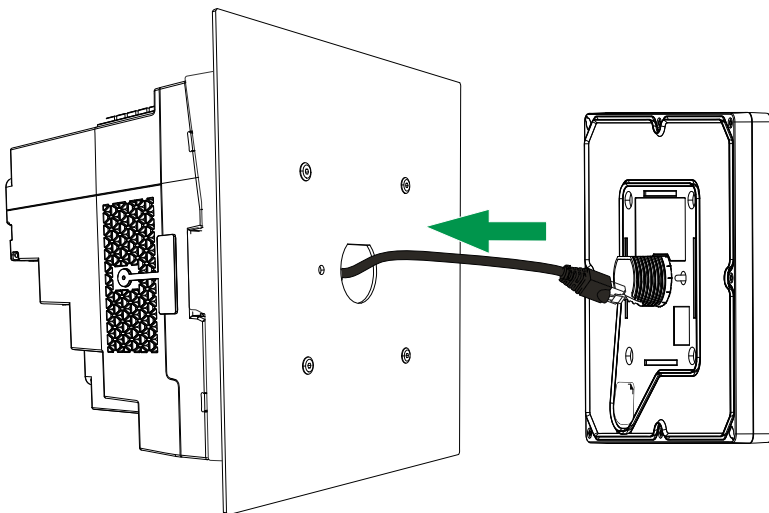

Removing the meter from back-to-back mounting adapter

You can uninstall the meter from the optional back-to-back mounting adapter.

NOTE: Refer to the meter installation sheet NVE78642 for installation instructions.

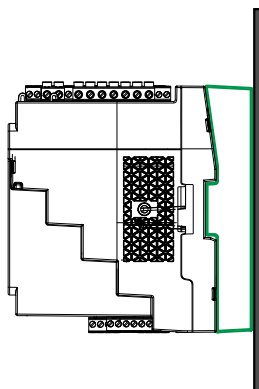

1. Use a flat-head screwdriver to unlock the meter retainer clips.

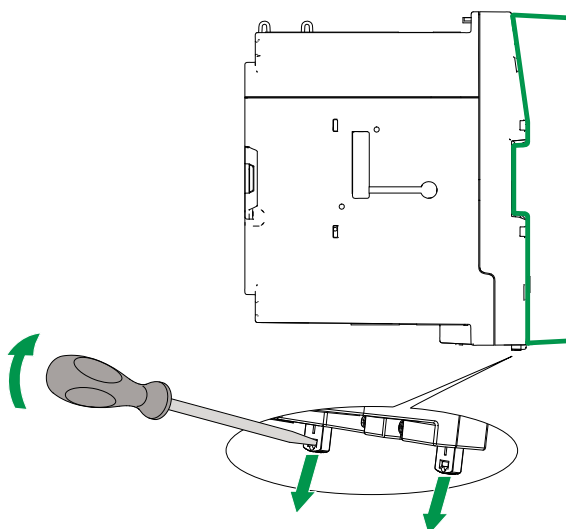

2. Holding the meter firmly, swing it outwards and pull slightly upwards to detach it from the top retaining hooks.

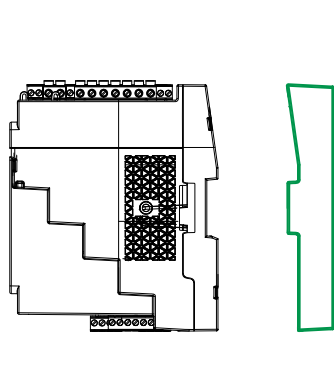
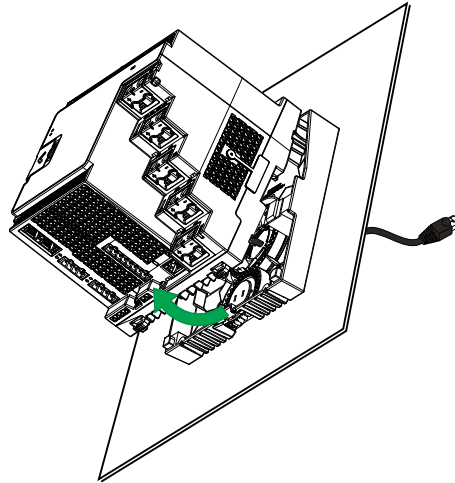

Option modules

Option modules are ordered separately from your meter, and can be connected to your meter without specialized equipment.

Option modules are identified based on how they physically connect to the meter's external I/O bus.

The first connected module, attached directly to the meter, is Module A. The second module, attached to Module A, is Module B. The meter supports up to 4 external modules:

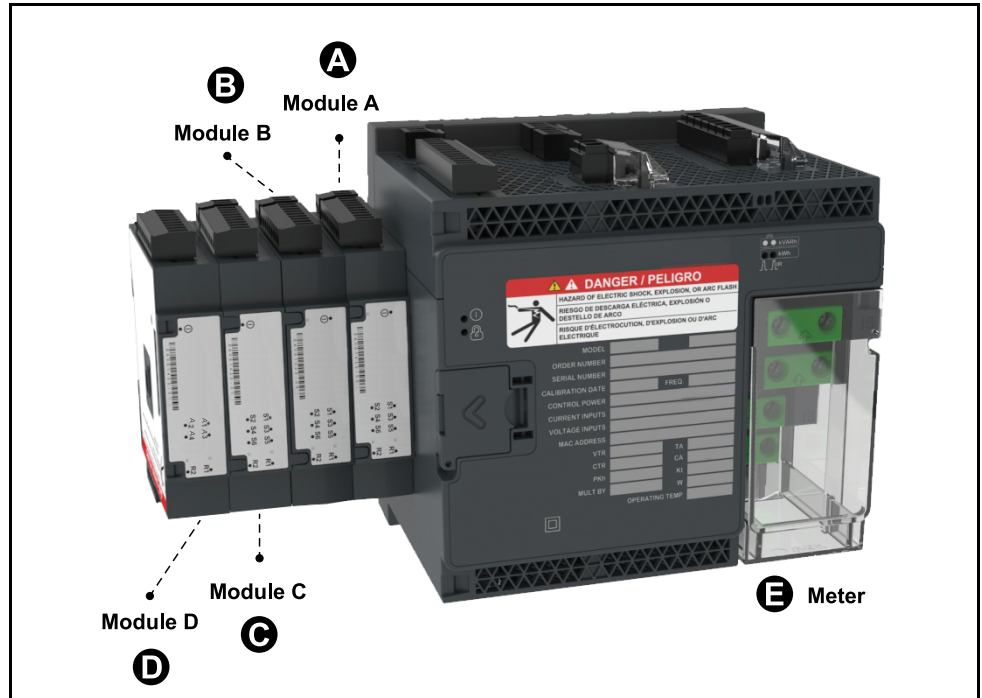

The option modules are monitored and controlled by the meter’s ION modules. External I/O modules are mapped to the corresponding ION modules:

Option module characteristic	ION module characteristic
Physical position: Module A to Module D	ION module label: Port A to Port D
Analog inputs A1 to A(n)	Analog Input module A1 to A(n)
Analog outputs Q1 to Q(n)	Analog Output module Q1 to Q(n)
Digital inputs S1 to S(n)	Digital Input module S1 to S(n)
Digital/relay outputs R1 to R(n)	Digital Output module R1 to R(n)

Maximum number of option modules

The maximum number of option modules supported by the device is four. However, there are limitations.

Depending on the type and quantity of option modules attached to your meter, you may need to reduce your meter’s maximum operating temperature or limit the number of option modules. Refer to *Maximum operating temperature with option modules*, page 217 for more information.

NOTICE
EQUIPMENT DAMAGE
Do not exceed the maximum number of option modules.
Failure to follow these instructions can result in equipment damage.

Commissioning

Factory default settings

Use these default values the first time you connect to your meter.

Parameter	Default value
Password to log onto meter webpages or access display	0
Username to log onto meter webpages	9000
IP address ¹	169.254.0.10
Subnet mask	255.255.0.0
Gateway	0.0.0.0
RS-485	COM1 Unit ID: 100 COM4 Unit ID: 103
Language	English

¹ The IPv6 link local address can also be used. Refer to *"Self-discovery over Ethernet"*, page 31 for details.

Commissioning using ION Setup

Use ION Setup to commission the meter for integration into your energy management system.

Connect to your meter using ION Setup then use the Setup Assistant to configure the meter. Setup parameters are arranged in logical groupings and category folders.

Before exiting the Setup Assistant, ION Setup performs a meter configuration test and displays the results. You can review the results and make changes as needed.

To turn off the meter configuration test:

1. Click **Tools > Options**.
2. Click the Assistant tab and clear the **Configuration Checklist** check box.

NOTE: ION Setup also performs a configuration test and displays results when configuring certain features such as the Sag/Swell or Transient Logging wizard in the Power Quality setup assistant.

Configure basic metering parameters

Use ION Setup's Metering setup assistant to configure the meter's basic metering functionality.

1. Start ION Setup then open the Setup assistant for your meter.

2. Configure the parameters in **Metering Setup > Basic**.**Basic tab**

Parameter	Values	Description
Volts Mode	4W-WYE, DELTA, 3W-WYE, SINGLE, DEMO	Power system type (note DEMO is demonstration mode only, and does not use the meter input terminals to display values)
PT Prim	1 to 999,999	Potential transformer's primary winding voltage rating
PT Sec	1 to 999,999	Potential transformer's secondary winding voltage rating
CT Primary	1 to 999,999	Current transformer's primary winding current rating
CT Secondary	1 to 999,999	Current transformer's secondary winding current rating
Nominal Voltage	1 to 999,999	Nominal voltage (V) used for metering functions such as harmonic calculations and sag/swell detection
Nominal Current	1 to 999,999	Nominal current (A) used for metering functions such as harmonic calculations and sag/swell detection
Nominal Frequency	50, 60	Nominal frequency (Hz) used for metering functions such as alarms

3. Configure the parameters in **Metering Setup > Advanced** if appropriate.**Advanced tab**

Parameter	Values	Description
PhaseOrder	ABC, ACB	Power system's rotation order of voltage phases
V4 PT Prim	1 to 999,999	V4 potential transformer's primary winding voltage rating
V4 PT Sec	1 to 999,999	V4 potential transformer's secondary winding voltage rating
I4 Prim	1 to 999,999	I4 current transformer's primary winding current rating
I4 Sec	1 to 999,999	I4 current transformer's secondary winding current rating
I5 Prim	1 to 999,999	I5 current transformer's primary winding current rating
I5 Sec	1 to 999,999	I5 current transformer's secondary winding current rating
Scale Rev Param	ON, OFF	Specifies whether revenue readings are presented as primary or secondary side values (ON = primary side, OFF = secondary side)

Using the phasor viewer

Phasor diagrams can help verify or troubleshoot issues with voltage and current input wiring.

Use ION Setup's Phasor Viewer to display a real-time phasor diagram of the voltage and current input signals.

1. Start ION Setup then open the Setup assistant for your meter.
2. Select **Metering Setup > Phasor**.
3. Select **Phasor Viewer** and click **Show**.

4. To change the polarity of the voltage or current inputs, click **Show Setup** to display the Polarity Settings. Select the box beside the inputs you want to invert polarity, then click **Apply to Meter**.

Basic setup using the webpages or display

You can use the meter webpages or display to configure basic metering parameters.

- Using the webpages: Navigate to **Setup > Metering**.
- Using the display: Navigate to **Setup Menu > Meter Setup**.

Communications

Communications overview

Communications is the transfer of data to and from the meter and is controlled by a combination of hardware and software components in the meter.

For each connected communications port, the meter uses the applicable communications protocol to establish communications with other devices or software. The protocol manages the communications session and defines the set of rules, commands and packet structure of the transmitted data. You can also control which protocols are enabled or disabled on the meter.

NOTE: To maximize the performance of your power management system, it is recommended that devices be connected directly to an Ethernet network.

Other means of controlling communications, such as who can access certain types of meter data, are discussed in the security topics for the meter.

Your meter's default protocol settings meet the needs of most systems with only basic configuration. You can customize these settings to meet your specific needs. These are advanced procedures that require an understanding of your meter's architecture, supported protocols, and the communications network and power system that your meter is connected to.

Ethernet communications

Your Ethernet connection source should be installed in a location that helps minimize the overall Ethernet cable routing length and complexity of your network.

The meter supports a single IP address for both physical Ethernet connections.

Your device's second Ethernet port acts as an Ethernet switch to help simplify network connections and reduce installation time and costs, by having shorter Ethernet cable runs between devices without needing additional Ethernet routers or repeaters. You cannot connect your meter to two different Ethernet networks. The two Ethernet ports do not split the signal, so connecting both of the ports should not impact your communications speed.

The meter uses dual-stack IPv4/IPv6 routing technology to manage network communications and allow network hosts to communicate with the meter using either IPv4 or IPv6.

Ethernet communications connections

Your meter's dual port Ethernet connections enable you to use straight-line or network loop (ring) topology.

If local network loop Ethernet topology is required, you must enable RSTP for your meter's Ethernet communications to function.

Use CAT5 (or higher) Ethernet cables with unshielded RJ45 modular connectors to wire your meter's Ethernet communications.

Ethernet loop topology

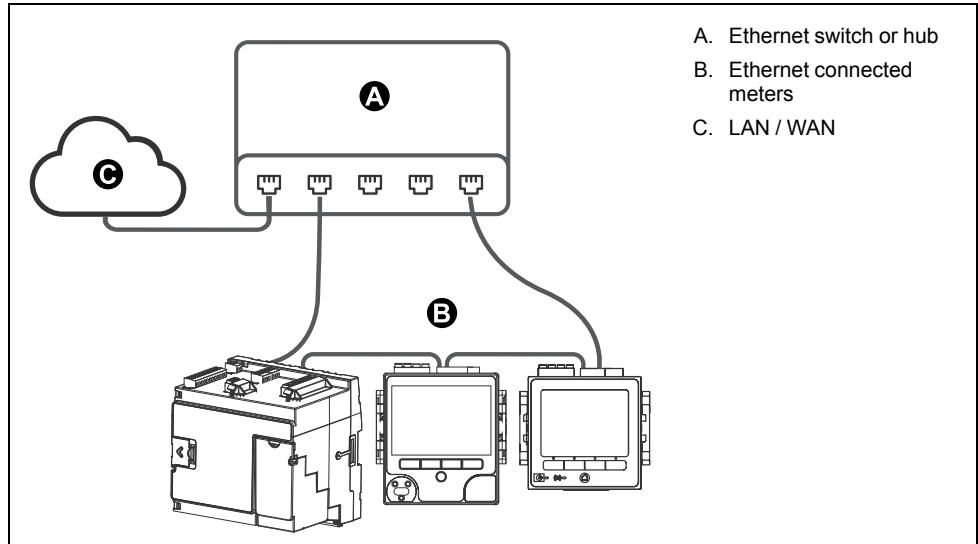

Protocols, ports and connections

The Ethernet protocols supported by your device allow simultaneous connections through the IP service ports.

NOTE: Some protocol port numbers are read-only and not configurable.

Protocol	Port (default)	Number of connections
ION	7700	8 ¹
DNP	20000	
DLMS	4059	
Modbus TCP ³	502	
Modbus RTU over Ethernet ³	7701	
Modbus TCP (dedicated) ³	502	32
EtherGate (Com1)	7801	1
EtherGate (Com4)	7802	1
DHCP	67 (68)	1
FTP	21 (20)	2
Webserver (HTTP) ²	80	10
Secure webserver (HTTPS) ²	443	10
SNMP	161	N/A
SMTP server (email) outgoing only	25	1
NTP	123	1
IEC 61850	102	5

¹ These 8 simultaneous connections are shared by ION, Modbus TCP, Modbus RTU over Ethernet, DNP and DLMS. You can have a maximum of 3 DNP connections. You can have a maximum of 1 DLMS connection.

² These are used for the meter’s webpages.

³ These protocols must be enabled for Modbus gateway functionality.

By enabling or disabling TCP/IP protocols, you can control whether or not your meter accepts new socket connection requests. Changing settings for one port does not impact the other existing connections. Depending on the protocol, you can also change the port number.

Related Topics

- Network protocol control

Self-discovery over Ethernet

Your meter supports DPWS (devices profile for web services) which allows for self-discovery of the meter when it is connected to your local area network.

When you connect your meter to your network, your meter automatically appears in your network in Windows Explorer under Other Devices. By default, the meter is named <meter type>-<last six digits of MAC address>. For example, a meter with a MAC address of 006078173393 appears on the network as <meter type>-173393.

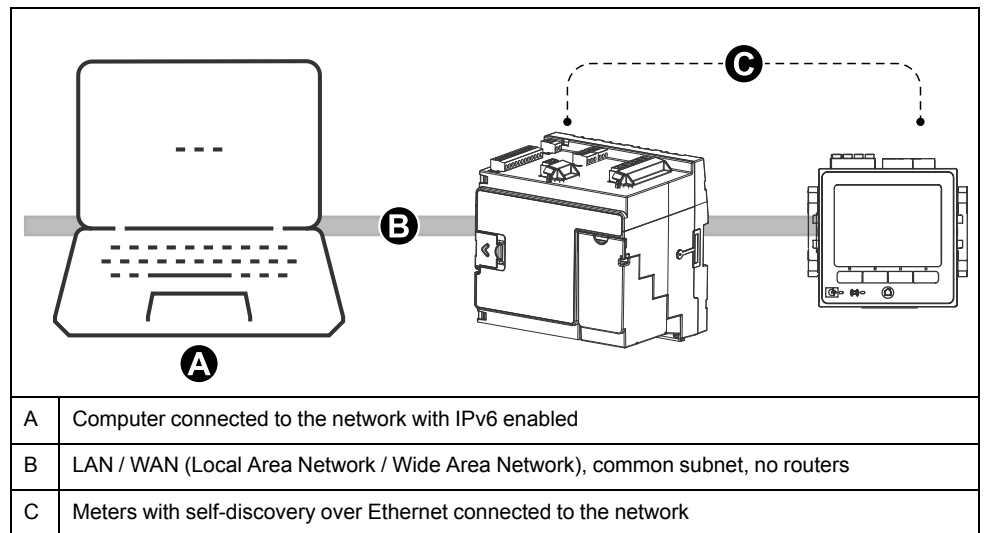

Considerations for using self-discovery over Ethernet

- For self-discovery, the meter must be connected directly to the network using only a cable or switches, and not going through a router.
- You must use a computer running Windows 7 or later with IPv6 enabled in order to use self-discovery over Ethernet.
- The computer and the meter must be on the same subnet.
- You do not need to configure your meter's IP address for self-discovery over Ethernet. An IPv6 address is automatically generated from your meter's MAC address and self-discovery takes place over IPv6.

Accessing the meter through self-discovery

You can use Windows Explorer to locate and access the meter on your Local Area Network (LAN).

NOTE: Some networks restrict device self-discovery over a wireless connection. If this is the case, make sure your computer is connected to the network using an Ethernet cable.

1. Connect the meter's Ethernet port to the LAN.
2. Start Windows Explorer.
3. Click Network.
The connected network devices display.
4. Locate your meter with the name <Device Name>-<Last 6 digits of MAC address>.
5. Double-click the icon to open the meter webpages.

Ethernet configuration

In order to use Ethernet communications, you must configure your device’s IP settings.

You need to enter network information for any Ethernet servers used by the device (for example, a DNS or email server). Contact your network system administrator for your IP address and other Ethernet network configuration values.

NOTE: For meters that do not have a display, you must connect your meter directly to your computer to set a unique IP address for each device or configure the meter to use a DHCP server to acquire IP addresses.

It is recommended that you test your communications with the meter after changing any communications-related settings (for example, communicating with the meter using the fully-qualified domain name if using DNS or with assigned addresses after these are provided by the DHCP server). In addition, make sure that any software or other devices communicating with the meter are using the new settings.

Initial Ethernet configuration versus changing existing Ethernet settings

There are two scenarios when configuring your meter’s Ethernet communications settings: initial configuration and changing the existing addresses when the meter is in use.

- Initial configuration: Configure your device’s Ethernet settings manually using the display or by connecting your meter directly to your computer and using a web browser to access the device’s webpages. Alternately, you can connect your meter to the network and configure it to use a DHCP server to acquire an IP address.

NOTE: It is recommended during initial configuration that you use a connection method other than the one you are trying to configure. For example, if you are configuring DHCP IPv4 settings, connect to the meter using the IPv6 LinkLocal address or a serial connection. This allows you to configure the meter without being disconnected.

- Changing existing IP settings: After the meter’s Ethernet port is configured and connected to the LAN, you can use ION Setup to configure meter settings, in addition to using the display or meter webpages.

In either case, modify your meter’s Ethernet settings to those provided by your network system administrator before connecting the device to your local area network (LAN).

IP address format and ranges

When you set your meter’s IPv4 or IPv6 addresses, make sure you use the correct format and valid ranges.

Protocol	Format
IPv4	0.0.0.0 to 255.255.255.255
IPv6	:: to FFFF:FFFF:FFFF:FFFF:FFFF:FFFF:FFFF:FFFF:FFFF The double colon indicates that gaps are filled with zeroes to make the IPv6 address the correct length (32 hexadecimal numbers)

All meters ship from the factory with the IPv6 global address and IPv6 gateway undefined (set to “::”). To communicate with the meter using IPv6 outside the local network, you must configure these settings manually or use DHCP to assign the addresses to the meter. Within the local network, you can use the meter’s IPv6 Link Local address.

IP addresses and network port numbers

To specify a port for an outgoing IP address, append a colon (:) then the port number to the end of the IP address. For IPv6 addresses, make sure the address

is enclosed in square brackets then append the port number. For example, to specify the default port for ftp (port 21), the format of the address is as follows:

- IPv4: 169.254.0.10:21
- IPv6: [FE80::260:78FF:FE04:5943]:21

Configurable Ethernet settings

'W' indicates the setting can be configured (written) while 'R' indicates it is read-only.

NOTE: Some additional Ethernet settings are available in the Advanced Ethernet menu in ION Setup and on the meter webpages.

Setting	Display	ION Setup	Webpages
IPv4 address	W	W	W
IPv4 Subnet mask	W	W	W
IPv4 Default gateway	W	W	W
IPv4 Assignment Mode (DHCP/Stored)	W	W	W
IPv6 Assignment Mode (DHCP/Stored)	W	W	W
Ethernet Device name	R	W	W
Domain name	R	W	W
IPv6 enabled	W	W	W
IPv6 Link Local Address	R	R	R
IPv6 global address	R	W	W
IPv6 gateway	R	W	W
Ethernet Rx timeout	—	W	W
Modbus TCP timeout	—	W	W
Modbus gateway	—	W	—
MAC address	R	R	R
Ethernet primary DNS	R	W	W
Ethernet secondary DNS	R	W	W

Configuring IPv4 / IPv6 communications settings using ION Setup

You can configure your device's IPv4 and IPv6 address settings, such as stored addresses or address assignment mode, using ION Setup.

When configuring communications parameters, ensure you maintain at least one communication path that allows full access to your device; otherwise you may permanently lose the ability to change your device's configuration and access additional data.

NOTICE
LOSS OF ACCESS
Ensure you maintain sufficient access to communicate with and configure your device.
Failure to follow these instructions can result in loss of access to the device.

Contact your network system administrator for your IP addresses and other Ethernet network configuration values.

1. Start ION Setup.
2. Open the **Setup Assistant** for your device.
3. Select **Communications > Basic Ethernet** and click the **IPv4** or **IPv6** tab.
4. Select the IP address then click **Edit**.
5. Select your IP address assignment mode.

IPv4

Selection	Mode	Description
Use DHCP to obtain an IPv4 address	DHCP	The meter acquires its IP addresses from your network's DHCP server. The Device Name and Domain Name fields are used to define the meter's fully-qualified domain name (FQDN).
Use the following IPv4 address	Stored	The meter uses the IP addresses that you manually enter for IPv4 (address, subnet mask and gateway).

For IPv6, select the **IPv6 Enabled** checkbox to enable IPv6 communications or clear it to disable IPv6 communications.

NOTE: The IPv6 Link Local address itself is factory set and is read-only.

IPv6

Selection	Mode	Description
Use DHCP to obtain an IPv6 address	DHCPv6	The meter acquires its IP addresses from your network's DHCPv6 server. The Device Name and Domain Name fields are used to define the meter's fully-qualified domain name (FQDN).
Use the following IPv6 address	Stored	The meter uses the IP addresses that you manually enter for IPv6 (global address and default gateway).

You can have different assignment modes for IPv4 and for IPv6.

6. Configure the settings for the selected mode then click **OK**.
The changes are saved to the meter. If ION Setup detects that the connection information is already in use, you are prompted to confirm the change.
7. Click **Yes** to confirm the change or **No** to cancel.

An example of an instance where you might want to confirm the change is if you are programming the meter to replace another meter already in service.

DHCP settings available using ION Setup

Parameter	Value	Description
Device name	Contact your local network administrator for parameter values.	The Ethernet device name is used by DPWS for self-discovery over Ethernet and as the hostname to uniquely identify your meter for DHCP and DNS. By default, this is set to the meter model plus the last six-digits of the MAC address.
Domain name	Contact your local network administrator for parameter values.	The Ethernet domain name for the network that the meter resides on.

Stored IPv4 settings available using ION Setup

Parameter	Value	Description
IP address	Contact your local network administrator for parameter values.	The IP address of your device.
Subnet Mask	Contact your local network administrator for parameter values.	The subnet IP address of your network.
Gateway	Contact your local network administrator for parameter values.	The gateway IP address of your network.

Stored IPv6 address settings available using ION Setup

Parameter	Value	Description
Global Address	Contact your local network administrator for parameter values.	The Internet protocol address of your device.
Default Gateway	Contact your local network administrator for parameter values.	The address the meter uses to route communications to a different network or subnet. If you do not set this or the address is incorrect, you may see slow communications or communications errors.

ION Setup reconnection

If you change the settings for the Ethernet connection method you are currently using to connect to the meter, ION Setup tries to reconnect to the meter using the updated information. You can view the process in the **Device reconnection** dialog box that appears.

- If ION Setup can successfully communicate using the new setting, this setting appears in the **IP Address** dropdown list and the checkbox is selected. Click **OK** to copy this information into the **IP address** field in the **Device Properties**. ION Setup will now use this address to communicate with the device.
- If ION Setup cannot successfully communicate using the new setting, the new address appears in the **IP Address** but the checkbox is not selected. Either select the checkbox and click **OK** (for example, you may want to use the new setting if you are replacing a meter in service) OR select another address option from the dropdown list. Click **Test** to check that ION Setup can communicate with the meter using the new address, select the checkbox, then click **OK**.

Configuring general Ethernet settings using ION Setup

You can configure your device’s general Ethernet settings using ION Setup.

1. Start ION Setup.
2. Open the **Setup Assistant** for your device.
3. Select **Communications > Basic Ethernet** and click the **TCP/IP** tab.

4. Select a setting and then click **Edit**.

NOTE: Contact your network system administrator for the appropriate values.

General Ethernet settings available using ION Setup

Parameter	Value	Description
Ethernet device name	configurable	This name is associated with your meter when using DPWS. By default, it is the meter type and the last 6 characters of its MAC address.
Rx timeout	configurable	Specifies the number of seconds the meter waits for communication acknowledgments.
Modbus TCP Timeout	configurable	Specify number of seconds the meter waits before disconnecting an idle Modbus TCP connection.
Modbus Gateway ¹	Disabled COM1 (CM1 Protocol) COM4 (CM4 Protocol)	Specify the port on which Modbus Gateway sends/ receives Modbus TCP requests. For Modbus Gateway to function properly, the serial port protocol must be set to Modbus Master. For example, change CM1 from FACTORY to MODBUS MASTER.
MAC address	Read-only	The media access control (MAC) address is factory set and is for reference only.

¹ Modbus Gateway is supported only on one serial port at any given time.

Configuring basic Ethernet settings using the meter webpages

You can use the meter webpages to configure the IPv4, IPv6 and TCP/IP settings for the meter.

When configuring communications parameters, ensure you maintain at least one communication path that allows full access to your device; otherwise you may permanently lose the ability to change your device’s configuration and access to additional data.

NOTICE
<p>LOSS OF ACCESS</p> <p>Ensure you maintain sufficient access to communicate with and configure your device.</p> <p>Failure to follow these instructions can result in loss of access to the device.</p>

Contact your network system administrator for your IP addresses and other Ethernet network configuration values.

1. Connect to your meter’s webpages.

Until you configure other Ethernet connection settings, you can connect to the meter using its default IPv4 address or its IPv6 link local address, or by using self-discovery over Ethernet then double-clicking the meter’s network icon.

2. Navigate to **Setup > Ethernet**.

3. Enter the appropriate value for the settings.

4. Click **Advanced Settings** to configure additional Advanced Ethernet settings, such as timeouts and enabling/disabling certain protocols over Ethernet, if needed.
5. Click **Apply**.

NOTE: If you are changing the address you used to access the webpages, you will need to reconnect to the webpages after you click **Apply**.

Ethernet settings available using the webpages

Parameter	Value	Description
MAC address	Read-only	The media access control (MAC) address is factory set and is for reference only.
Ethernet device name	configurable	The Ethernet device name is used by DPWS for self-discovery over Ethernet and as the hostname to uniquely identify your meter for DHCP and DNS. By default, this is set to the meter model plus the last six-digits of the MAC address.
Domain name	Contact your local network administrator for parameter values.	The Ethernet domain name for the network that the meter resides on.
Primary DNS	Contact your local network administrator for parameter values.	The IP address of your network's primary DNS server, if your network uses DNS.
Secondary DNS	Contact your local network administrator for parameter values.	The IP address of your network's secondary DNS server, if your network uses DNS.

IPv4 settings available using the webpages

Parameter	Value	Description
IPv4 Assignment mode	Stored DHCP	Stored: The meter uses the IP addresses that you manually enter for IPv4 (address, subnet mask and gateway). DHCP: The meter acquires its IP addresses from your network's DHCP server.
Stored IPv4 address	Contact your local network administrator for parameter values.	The Internet protocol address of your device.
Stored IPv4 Subnet Mask	Contact your local network administrator for parameter values.	The Ethernet IP subnetwork address of your network.
Stored IPv4 Gateway	Contact your local network administrator for parameter values.	The Ethernet IP gateway address of your network.
The webpage also displays the acquired IPv4 settings if the Assignment mode is set to DHCP. NOTE: To disable communications using IPv4, set the Assignment mode to Stored and the IPv4 Address to 0.0.0.0.		

IPv6 settings available using the webpages

Parameter	Value	Description
IPv6 Assignment Mode	Stored DHCPv6	Stored: The meter uses the IP addresses that you manually enter for IPv6 (Global address, gateway address). DHCPv6: The meter acquires its IP addresses from your network's DHCP server.
IPv6 Link Local Address	Read-only	The IPv6 Link Local address is factory set and is read-only.
Stored IPv6 Global Address	Contact your local network administrator for parameter values.	The Internet protocol address of your device.
Stored IPv6 Gateway	Contact your local network administrator for parameter values.	The address the meter uses to route communications to a different network or subnet. If you do not set this or the address is incorrect, you may see slow communications or communications errors.

The webpage also displays the acquired IPv6 settings if the Assignment mode is set to DHCP.

NOTE: To disable communications over IPv6, set **Enable IPv6** in **Advanced Settings** to "No".

NOTE: You must enclose an IPv6 address in square brackets when typing it in a web browser, for example: "http://[fe80::260:78ff:fe04:5943]".

Configuring Ethernet communications settings using the display

You can configure basic Ethernet communications settings using the display.

Obtain your meter's IP address and other network information from your network administrator or IT department before you begin.

You can use the display to select the IP address assignment mode for IPv4 and IPv6, configure stored IPv4 addresses, and view other settings. To configure the Ethernet settings that are not available on the display or are read-only, use the meter's webpages or ION Setup.

1. Go to **Setup Menu > Communications Setup**.
2. Scroll through the screens until you reach the setting you want to configure then press the edit icon.
3. Select the IPv4 or IPv6 **Assignment Mode**, if required.

Option	Description
Stored	The meter uses the IP addresses that you manually enter for IPv4 (address, subnet mask and gateway) and IPv6 (Global address, gateway address).
DHCP / DHCPv6	The meter acquires its IP addresses from your network's DHCP server.

You can have different assignment modes for IPv4 and for IPv6.

If you set the **IPv4 Assignment Mode** to Stored, continue with the remaining steps to configure stored IPv4 addresses. If you are using addresses acquired from a DHCP server, press the down arrow to view the assigned addresses.

4. Go to the **Stored IPv4 Address Setup** screen and press the edit icon.

5. Configure your meter's stored IPv4 Addresses, as required.

Stored IPv4 address settings available using the display

Parameter	Values	Description
IP Address	Contact your local network administrator for parameter values.	Sets the IP address for the meter Your meter's default IP address is 169.254.0.10
Subnet Mask	Contact your local network administrator for parameter values.	Used if subnetting applies to your network Your meter's default subnet address is 255.255.0.0
Gateway	Contact your local network administrator for parameter values.	Used in networks with multiple segments Your meter's default gateway address is 0.0.0.0
MAC Address	Read-only	Your meter's media access control (MAC) address

DHCP

The meter can function as a DHCP (Dynamic Host Configuration Protocol) client, allowing a DHCP server to assign IP addresses to the meter.

The meter supports assignment of the following addresses by a DHCP server when the Assignment Mode is set to DHCP:

- IPv4 IP Address
- IPv4 Subnet mask
- IPv4 Gateway
- IPv6 Global Address
- IPv6 Gateway

Considerations for using DHCP

- It is recommended that you also set up a DNS server and configure software and other devices to use the meter's name to communicate with it. Alternatively, you can configure the DHCP server to always provide the same address to the meter.
- When you switch the assignment mode from DHCP to Stored, the meter reverts to using its default IP addresses as the Stored addresses.
- When you switch the assignment mode from Stored to DHCP, the acquired addresses display as **None** until the meter receives addresses from the DHCP server.
- When using IPv6, the meter's fully-qualified domain name (FQDN) is not sent to the DHCP server. It is important that you make sure what is configured on the meter matches what is configured on your network.
- If the meter is not able to communicate to the DHCP server:
 - When using IPv4, the meter will try to connect to the DHCP server for approximately one minute. If the meter cannot connect to the DHCP server, it will revert to the default IP address, but the Assignment Mode will remain DHCP.
 - When using IPv6, the meter will continue to try to connect to the DHCP server, even if it does not receive an address.

NOTE: If the DHCP server has not assigned an IP address and you need to reconnect to the meter, use the meter's IPv6 link-local address.

- For IPv4, if the meter's fully-qualified domain name (FQDN) is not found on the DHCP server, an event is logged in the event log. For IPv6, if the meter's fully-qualified domain name (FQDN) is not found on the DHCP server, no event is logged; this is important to keep in mind when troubleshooting communications issues in a system using DHCP.

Meter domain name

You can configure the meter as a DNS client in systems using a DNS server.

Domain name resolution (DNS)

A DNS (domain name system) server maps domain names to IP addresses. If you configure the meter to use a DNS server, the meter can communicate with other network resources using their domain names, rather than their IP addresses, and vice versa. For example, if your network has an SMTP server with the domain name of smtp.company.com, you can enter smtp.company.com as the SMTP Server address in the meter’s communications settings.

The meter’s fully-qualified domain name (FQDN)

To allow other network resources to communicate to the meter using its domain name, you must configure the meter’s Ethernet Device Name setting to match that used by the DNS server. The meter’s fully-qualified domain name is its Ethernet name plus its Domain name. For example, if the meter’s Ethernet name is ElectricityHQ and its Domain name is companyXYZ.com, the FQDN will be ElectricityHQ.companyXYZ.com.

NOTE: This domain name is used for both IPv4 and IPv6 communications. It is used to identify the meter in a system using DNS and to identify the meter when using DPWS for self-discovery over Ethernet.

Network protocol control

The network protocol control feature allows you to enable, disable or change the port number of the network protocols supported on your meter.

Disabling unused ports is considered a cybersecurity best practice to help minimize unauthorized access to your meter.

NOTE: The protocol port number may not be configurable on all protocols.

Related Topics

- Protocols, ports and connections

Network protocol control using ION Setup

Use ION Setup to enable, disable or change the port number of the network protocols supported on your meter.

When configuring communications parameters, ensure you maintain at least one communication path that allows full access to your device; otherwise you may permanently lose the ability to change your device’s configuration and access to additional data.

<i>NOTICE</i>
LOSS OF ACCESS
Ensure you maintain sufficient access to communicate with and configure your device.
Failure to follow these instructions can result in loss of access to the device.

1. Open the Setup Assistant for your meter.
See the ION Setup Help for instructions.
2. Select **Communications > Advanced Ethernet** and click the **Protocols** tab.
Enter your login credentials as required.

3. Select a protocol from the list and click **Edit**.
4. Select the **Enabled** checkbox to enable the port. Clear the checkbox to disable the port.

NOTE: The IEC61850 port is enabled when a valid CID file is uploaded to the meter. The port is disabled by removing the CID file.

NOTE: For EtherGate functionality, the EtherGate protocol must be enabled and the applicable serial port set to **EtherGate**.
5. Select a port number from the **Port Number** dropdown list or by clicking in the **Port Number** field and entering a port number.
6. Click **OK**.

If multiple ports are set to the same number, ION Setup responds with a message indicating that the port is already in use by another protocol.

NOTE: When configuring the FTP ports, the data connection port is automatically assigned to the command connection port number minus 1. For example, if the command connection port number is 21, the data connection port number is automatically set to 20.

Network protocol control using the meter webpages

Use the meter webpage to enable, disable or change the port number of the network protocols supported on your meter.

The Setup tab contains configurable elements for enabling, disabling and changing the port numbers for your network protocols.

When configuring communications parameters, ensure you maintain at least one communication path that allows full access to your device; otherwise you may permanently lose the ability to change your device’s configuration and access to additional data.

<i>NOTICE</i>
<p>LOSS OF ACCESS</p> <p>Ensure you maintain sufficient access to communicate with and configure your device.</p> <p>Failure to follow these instructions can result in loss of access to the device.</p>

1. Open a web browser and enter your meter’s IP address in the address box.

The webpage login is displayed.
2. Enter your login credentials.
3. Navigate to **Setup > Ethernet**.
4. Click **Advanced Settings** at the bottom of the screen.
5. Select YES or NO to enable or disable each configurable protocol.
6. Enter the port number for each configurable protocol.
7. Click **Apply** to send these settings to your meter.

Network protocol control using the meter display

The Ethernet Port Enable Setup allows you to enable or disable your network protocols through your meter’s display.

When configuring communications parameters, ensure you maintain at least one communication path that allows full access to your device; otherwise you may permanently lose the ability to change your device’s configuration and access to additional data.

NOTICE

LOSS OF ACCESS

Ensure you maintain sufficient access to communicate with and configure your device.

Failure to follow these instructions can result in loss of access to the device.

NOTE: You cannot change the Ethernet port number assignments through your meter's display.

1. Press the **Home** button on the display.
2. Navigate to **Setup Menu > Ethernet Port Enable Setup**.
3. Press Edit. Enter your meter's password, if prompted.
4. Press the up or down icons to navigate available Ethernet protocols. A gray bar appears behind the active selection.
5. To select the item(s):
 - Press Enable/Disable, or
 - Press the up and down icons simultaneously.
6. Press Select to accept the change.
7. Press Select to confirm.

Serial communications

The meter supports serial communications through its onboard RS-485 ports.

RS-485

In an RS-485 network, there is one master device, typically an Ethernet to RS-485 gateway. It provides the means for RS-485 communications with multiple slave devices (for example, meters). For applications that require only one dedicated computer to communicate with the slave devices, a USB to RS-485 converter can be used to connect to the master device.

Up to 32 devices can be connected on a single RS-485 bus.

RS-485 wiring

Connect the devices on the RS-485 bus in a point-to-point configuration, with the (+) and (-) terminals from one device connected to the corresponding (+) and (-) terminals on the next device.

RS-485 cable

Use a shielded 2 twisted pair or 1.5 twisted pair RS-485 cable to wire the devices. Use one twisted pair to connect the (+) and (-) terminals, and use the other insulated wire to connect the C terminals

The total distance for devices connected on an RS-485 bus should not exceed 1200 m (4000 ft).

RS-485 terminals

C	Common. This provides the voltage reference (zero volts) for the data plus and data minus signals
	Shield. Connect the bare wire to this terminal to help suppress signal noise that may be present. Ground the shield wiring at one end only (either at the master or the last slave device, but not both).
-	Data minus. This transmits/receives the inverting data signals.
+	Data plus. This transmits/receives the non-inverting data signals.

NOTE: If some devices in your RS-485 network do not have the C terminal, use the bare wire in the RS-485 cable to connect the C terminal from the meter to the shield terminal on the devices that do not have the C terminal.

RS-485 configuration

Before connecting your device to the RS-485 bus, use ION Setup, the meter webpages or display to configure your meter’s default RS-485 settings.

Your meter has two RS-485 connections.

Each RS-485 connection must have a unique unit identifier (Unit ID) and have the following settings match the rest of the devices on the RS-485 bus:

- Protocol
- Baud rate
- Parity and stop bits

You can configure the following settings to help optimize communications performance:

- RTS delay
- RS-485 bias

You can use a communications converter (USB to RS-485 or RS-232 to RS-485) or an Ethernet gateway device to connect to your meter.

RS-485 Bias

You can use the RS-485 bias setting to fine tune communications.

Set the RS-485 bias to ON when the meter is acting as a master over RS-485 communications, and set the RS-485 bias to OFF when the meter is acting as a slave. You can configure RS-485 biasing through ION Setup, the meter webpages or display.

Serial protocols and ports

Your meter supports serial communications protocols on its RS-485 ports.

- | | |
|--|---|
| <ul style="list-style-type: none"> • ION • Modbus RTU • Modbus Master • DNP 3.0 • EtherGate | <ul style="list-style-type: none"> • GPS: Truetime/Datum ¹ • GPS: Arbiter ¹ • GPS: Arbiter-Vorne ¹ • None ² |
|--|---|

¹ These protocol settings are used for connecting to a GPS receiver communicating in serial ASCII format.

² This protocol setting stops communications using this port.

Configuring serial communications settings using ION Setup

Use ION Setup to configure the meter’s serial communications settings.

Before configuring serial parameters, make sure you have a unique unit ID for your meter and know the serial network settings (protocol, baud rate, parity and stop bits).

1. Start ION Setup.
2. Open the **Setup Assistant** for your device.
3. Select **Communications > Serial Settings** .
4. Select Com1 or Com4 tab, depending on which hardware serial port you are configuring.
5. Select a setting and then click **Edit** to configure the setting to match your communications system.

Serial communications settings available using ION Setup

Parameter	Values	Description
Protocol	ION, Modbus RTU, Modbus Master, DNP v3.00, EtherGate, GPS: Truetime/Datum, GPS: Arbiter, GPS: Arbiter-Vorne, Factory, None	Sets the communications protocol for your meter's RS-485 port NOTE: the NONE setting stops communications using this port.
Baud Rate	2400, 4800, 9600, 19200, 38400, 57600, 115200	Sets the data rate, in bits per second
Rx Timeout	0.1–15	Sets the transmit delay (timeout for receiving an entire message from a device) in seconds ¹
Unit ID	1 to 9999	Sets the meter's unique ID on the RS-485 network NOTE: Modbus serial device range 1 to 247
Serial Port	8N1, 8N2, 8E1, 8E2, 8O1, 8O2	Sets the parity and stop bits for the port
RS485 Bias	Off, On	Turns on biasing when mastering devices over the RS-485 port

¹ Only applies to a subset of protocols

Configuring serial communications settings using the webpages

You can use the meter's webpages to configure your serial communications settings.

Before configuring serial parameters, make sure you have a unique unit ID for your meter and know the serial network settings (protocol, baud rate, parity and stop bits).

1. Connect to your meter's webpages using the meter's IPv4 address or its IPv6 link local address, or use self-discovery then double-clicking the meter's network icon.
2. Navigate to **Setup > Serial Port**.
3. Enter the appropriate value for the settings.

- Click **Advanced Settings** to configure additional settings, if needed (for example, RS485 biasing or Rx Timeout).

Basic serial communications settings available using the webpages

Parameter	Values	Description
Protocol	ION, Modbus RTU, Modbus Master, DNP v3.00, EtherGate, GPS: Truetime/Datum, GPS: Arbiter, GPS: Arbiter-Vorne, Factory, None	Sets the communications protocol for your meter's RS-485 port NOTE: the NONE setting stops communications using this port.
Baud Rate	2400, 4800, 9600, 19200, 38400, 57600, 115200	Sets the data rate, in bits per second
Unit ID	1 to 9999	Sets the meter's unique ID on the RS-485 network NOTE: Modbus serial device range 0 to 247

Advanced serial communications settings available using the webpages

Parameter	Values	Description
RTS Delay	0–1	The delay in seconds before the transmission of the packet.
Rx Timeout	0.1–15	Sets the transmit delay (timeout for receiving an entire message from a device) in seconds ¹
Serial Port	8N1, 8N2, 8E1, 8E2, 8O1, 8O2	Sets the parity and stop bits for the port
RS485 Bias	OFF, ON	Turns on biasing when mastering devices over the RS-485 port

¹ Only applies to a subset of protocols

Configuring serial communications using the display

You can configure your meter's basic serial communications settings using the display.

Before configuring serial parameters, make sure you have a unique unit ID for your meter and know the serial network settings (protocol, baud rate, parity and stop bits).

- Press the **Home** button.
- Navigate to **Setup Menu > Communications Setup**.
- Press the up and down icons to scroll and select **COM1 Setup** or **COM4 Setup**.

- Configure your meter's serial settings as required.

Serial communications settings

Parameter	Values	Description
Protocol	ION, Modbus RTU, Modbus Master, DNP v3.00, EtherGate, GPS: Truetime/Datum, GPS: Arbiter, GPS: Arbiter-Vorne, Factory, None	Sets the communications protocol for your meter's RS-485 port NOTE: the NONE setting stops communications using this port.
Baud Rate	2400, 4800, 9600, 19200, 38400, 57600, 115200	Sets the data rate, in bits per second
Rx Timeout	0 to 1	Sets the transmit delay in seconds
Unit ID	1 to 9999	Sets the meter's unique ID on the RS-485 network NOTE: Modbus serial device range 1 to 247
Serial Port	8N1, 8N2, 8E1, 8E2, 8O1, 8O2	Sets the parity and stop bits for the port
RS485 Bias	OFF, ON	Turns biasing off or on when mastering devices over the RS-485 port

Disabling serial communications ports

Disabling serial communications using ION Setup

You can disable serial communications ports (COM1 or COM4) through ION Setup.

Disabling unused ports is considered a cybersecurity best practice to help minimize unauthorized access to your meter.

- Open the Setup Assistant for your meter. See the ION Setup Help for instructions.
- Select **Communications > Serial Settings**.
- Click the **COM1** or **COM4** tab, depending on which serial port you want to disable.
- Select **Protocol** and click **Edit**.
- Select **None** from the dropdown list and click **OK**.

Disabling serial communications using the meter webpages

You can disable serial communications ports (COM1 or COM4) through the meter webpages.

Disabling unused ports is considered a cybersecurity best practice to help minimize unauthorized access to your meter.

- Open a web browser and enter your meter's IP address in the address box. The webpage login prompt is displayed.
- Enter your login credentials.
- Navigate to **Setup > Serial Port** and expand the **Basic Settings** section.
- Depending on which serial port you are disabling, use the dropdown list for **COM1/ RS485#1 - Protocol** or **COM4/ RS485#2 - Protocol** and select **None** to disable the port.
- Click **Apply**. When prompted, click **Yes** to save the changes.

Disabling serial communications using the display

You can disable serial communications ports (COM1 or COM4) through the display.

Disabling unused ports is considered a cybersecurity best practice to help minimize unauthorized access to your meter.

1. Press the **Home** button.
2. Navigate to **Setup Menu > Communications Setup**.
3. Press **Select**.
4. Scroll then select **COM1 Setup** or **COM4 Setup**, depending on which serial port you are disabling.
5. Press the navigation icon to scroll and select **Protocol**.
6. Press **Edit**. Enter user credentials if prompted.
7. Press the down icon and select **None** to disable the port.
8. Press **Select** when you are finished. If prompted, press **Select** again to accept the changes.

ION

ION is the native protocol and architecture of your meter.

The basic building blocks of ION architecture are the ION modules, each of which is specialized to perform a specific task and contains data and instructions on how to manage that data. ION modules are combined (linked) together to create the meter's functions and features. ION modules that are linked together to perform a specialized task are called a framework, such as the Power Quality framework. These different functional frameworks are then grouped together to define the entire meter, and are collectively referred to as the device template.

Your meter ships with a default device template which provides extensive capabilities. You can also configure your meter's template to modify your meter's existing functions or to create new functions.

See the ION Reference, available from www.schneider-electric.com for further information about ION architecture and a detailed description of the different ION modules. See the ION Device Template Reference, available from www.schneider-electric.com, for details on the modules and their configuration in your meter's default template.

Modbus

Modbus is a master/slave communications protocol where the master initiates transactions and the slave(s) responds with the requested information or action.

Your device can function as a Modbus slave or Modbus master, depending on how it is configured. Your device comes with Modbus slave functionality configured and ready to use. You can add custom Modbus information to the default Modbus slave data provided by your device.

Key terms

Term	Definition
Modbus gateway	A communications method that lets you communicate through an Ethernet gateway device to a Modbus serial network connected to that device.
Modbus master	A device that issues commands and receives responses from Modbus slave devices. Serial Modbus networks can only have one Modbus master per network.
Modbus RTU	Serial Modbus protocol format; Modbus RTU transmits data using binary. Master and slave devices must use the same format.
Modbus register/address	Identifies the data to read/write. Modbus register maps are available for Modbus slave devices and detail the information available from the slave device. More than one register may be used to store a single value.
Modbus slave	A device that responds to Modbus commands and performs actions or provides information back to the Modbus master. Most Modbus networks contain multiple slave devices.
Modbus TCP	The Ethernet Modbus protocol format.
Modbus unit ID	The identifier for a slave Modbus device.

You can download your device's Modbus map from www.schneider-electric.com and get additional information about the Modbus protocol from www.modbus.org.

Modbus best practices for Ethernet

In order for your meter to operate as an Ethernet Modbus device, you must complete some prerequisite configuration.

NOTE: You do not need to perform any Modbus-specific configuration for your meter to function as a Modbus slave device over Ethernet.

Prerequisite	Description
Ethernet	All devices must have a working Ethernet connection.
IP address	All devices must have a unique IP address.
Port	All devices must be communicating over Ethernet port 502 for Modbus TCP.

NOTE: Devices supporting multiple simultaneous Modbus TCP connections can have communications delays. Adjust your network timeout settings to accommodate this.

Modbus best practices for serial

In order for your meter to operate as a serial Modbus device, you must complete some prerequisite configuration.

Prerequisite	Description
Wiring	The device's serial connection must be wired correctly. The Modbus slave devices must have communications wiring to the Modbus master.
Protocol	Slave: for your meter to be a serial Modbus slave, the meter's protocol must be set to Modbus RTU. Master and slave devices must use the same format. Master: for your meter to be a serial Modbus master, the meter's protocol must be set to Modbus Master.
Baud rate	The baud rate must be the same for all devices on the serial Modbus network.
Stop bits and parity	The communication stop bits and parity (for example, 8N1) must be the same for all devices on the serial Modbus network.
Unit ID	Each device on the serial Modbus network must have a unique unit ID (also called the device address).

Your meter as a Modbus master

Your meter as a Modbus master with Ethernet Modbus slave devices

Your meter can function as a Modbus master with Ethernet Modbus slave devices.

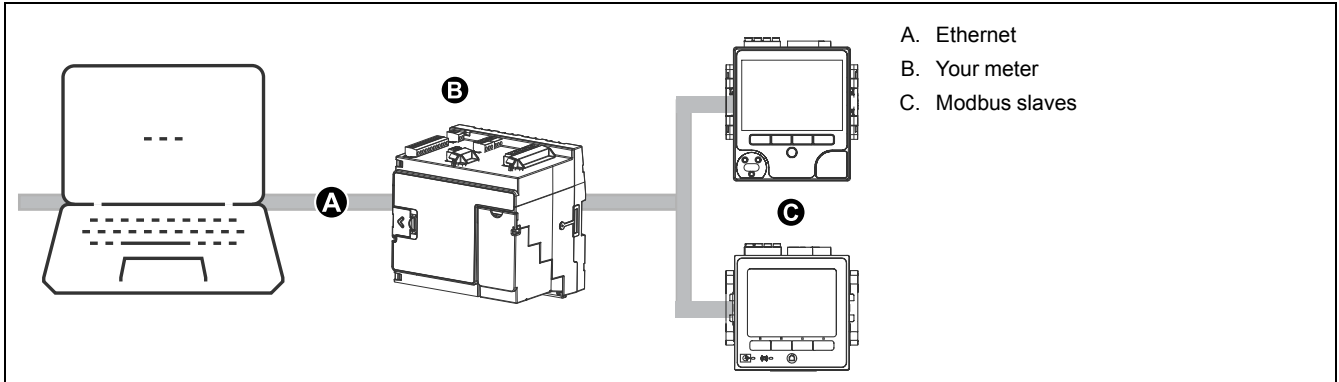

For Modbus mastering, you must add the Modbus slave devices using ION Setup.

Your meter as a Modbus master with serial Modbus slave devices

Your meter can function as a Modbus master with serial Modbus slave devices.

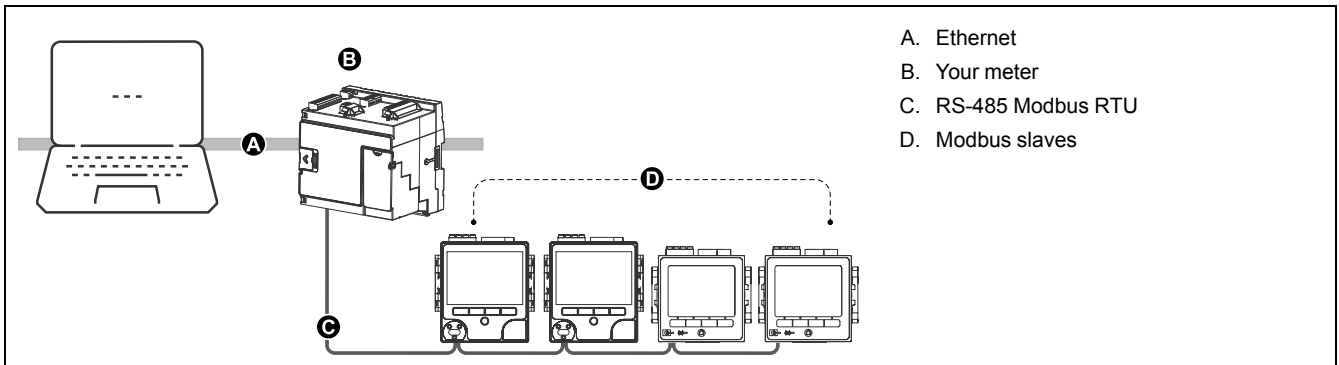

For Modbus mastering, you must add the Modbus slave devices using ION Setup.

Modbus master best practices

In order for your meter to operate as a Modbus master, you must complete some prerequisite configuration.

NOTE: These settings are required in addition to the serial or Ethernet Modbus prerequisites.

Prerequisite	Description
Modbus slave devices	All Modbus slave devices must be communicating and appropriately configured.
Protocol	<ul style="list-style-type: none"> Modbus mastering serial devices: the master's serial port protocol must be set to Modbus master. Modbus mastering Ethernet devices: the master must be communicating to the slave devices over Ethernet port 502. <p>NOTE: Having more than one Modbus master on a serial Modbus network may cause communication conflicts.</p>
Mastered devices	The Modbus master device must have the slave device information entered for mastering.

Configuring your meter as a Modbus master using ION Setup

You can configure your device to Modbus master slave devices over serial or Ethernet.

Make sure your master and slave devices have the prerequisite communications wiring and configuration before configuring your meter as a Modbus master.

If the meter is a Modbus master over TCP/IP, the Modbus TCP/IP and Modbus RTU protocols must be enabled.

NOTE: Devices supporting multiple simultaneous Modbus TCP connections can have communications delays. Adjust your network timeout settings to accommodate this.

The meter as a Modbus master over TCP/IP attempts to communicate with a slave device for up to 100 seconds (as per the RFC1122 standard) before moving on to the next slave device.

1. Start ION Setup.
2. Open the Setup Assistant for your meter.
3. Navigate to **Communications > 3rd Party Protocols** and click on the **Modbus Master** tab.
4. Click **Add** to add a Modbus slave device. The Modbus Device dialog appears.
5. Enter the Modbus slave information:
 - Enter the Modbus slave device’s name and a label suffix (if applicable).
 - Select the device type of the slave device from **Device Type**.
 - Enter the unit ID of the Modbus slave device into **Slave ID**.
 - Select the serial or TCP connection from **Connected via**. This is the connection from the Modbus master to the slave device.
6. Click **Connections**. The Modbus Master Connections dialog appears.
7. Select the tab that corresponds to the connection you are configuring (for example, if you selected TCP Connection 1 from **Connected via**, select the TCP 1 tab) and configure it based on the connection type.

Connection type	Configuration
Serial connection	Select the serial communications port that is connected to the Modbus slave devices from the Assigned Port list.
TCP connection	Enter the IP address of the Modbus slave device, making sure that the IP port is set to 502. Make sure that the Modbus RTU and Modbus TCP/IP protocols are enabled.

8. Click **OK** to return to the Modbus Device dialog.
9. Click **OK** to add the slave device. The device now appears on the list. Repeat these steps to add all of your Modbus slave devices.

Related Topics

- [Configuring your meter as a Modbus slave using ION Setup](#)

Your meter as a Modbus slave

Your meter as a Modbus slave over Ethernet

Your meter can function as a Modbus slave over Ethernet.

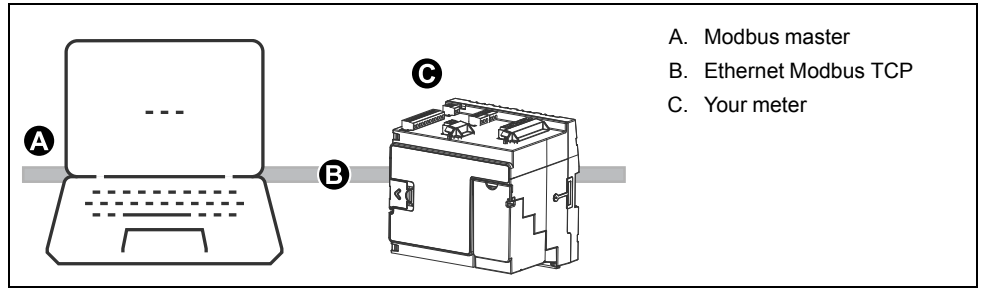

Your meter does not require any Modbus-specific configuration to act as a Modbus slave device over Ethernet.

Your meter as a Modbus slave on a serial network

Your meter can function as a Modbus slave on a serial network.

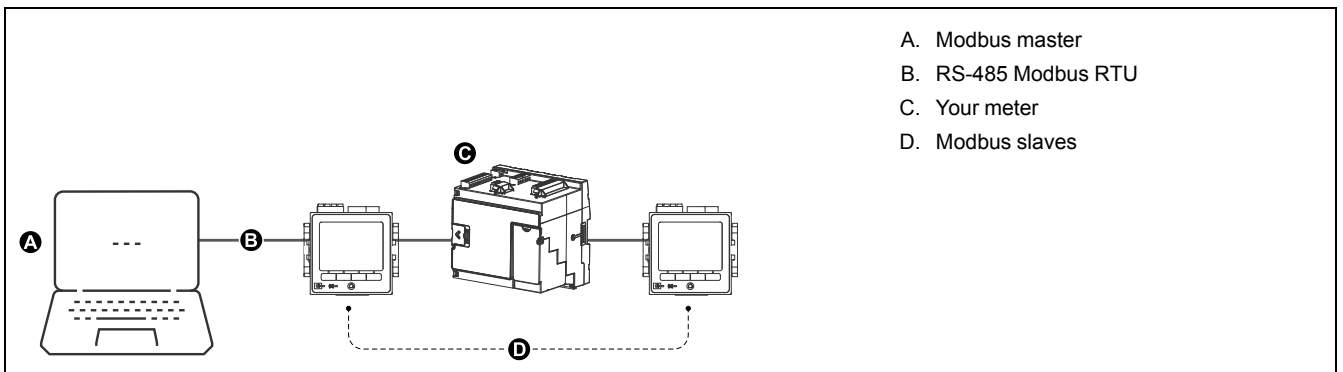

Your meter’s serial connection must be wired and configured correctly. The same mode of serial communication must be used for all devices on the network.

Configuring your meter as a Modbus slave using ION Setup

You can use ION Setup to configure your meter as a Modbus slave.

1. Start ION Setup.
2. Open the Setup Assistant for your meter.
3. Navigate to **Communications > Serial settings**. Select the tab for the serial port you want to configure.
4. Highlight the parameter and click **Edit** to configure the serial port’s Modbus parameters as required.

Parameter	Setting
Protocol	Modbus RTU or Modbus Master
RS485 Bias	<ul style="list-style-type: none"> • OFF if the meter is a Modbus slave • ON if the meter is a Modbus master

5. Configure the meter’s other serial port parameters as required.

For Modbus mastering, you must add the Modbus slave devices using ION Setup.

See your device’s Modbus map, available from www.schneider-electric.com for Modbus register information.

Related Topics

- Configuring your meter as a Modbus master using ION Setup

Configuring your meter as a Modbus slave using the webpages

You can use the meter webpages to configure your meter as a Modbus slave.

1. Connect to your meter’s webpages.
2. Navigate to **Setup > Serial Port**.
3. Expand Basic Settings or Advanced Settings and configure the serial port’s Modbus parameters as required.

Parameter	Setting
Protocol	Modbus RTU or Modbus Master
RS485 Bias	<ul style="list-style-type: none"> • OFF if the meter is a Modbus slave • ON if the meter is a Modbus master

4. Configure the meter’s other serial port parameters as required.

For Modbus mastering, you must add the Modbus slave devices using ION Setup.

See your device’s Modbus map, available from www.schneider-electric.com for Modbus register information.

Related Topics

- Configuring your meter as a Modbus master using ION Setup

Configuring your meter as a Modbus slave using the display

You can use the display to configure your meter as a Modbus slave.

1. Press the **Home** button.
2. Navigate to **Setup Menu > Communications Setup**, scroll and select COM1 Setup or COM4 Setup.
3. Configure the serial port’s Modbus parameters as required.

Parameter	Setting
Protocol	Modbus RTU or Modbus Master
RS485 Bias	<ul style="list-style-type: none"> • OFF if the meter is a Modbus slave • ON if the meter is a Modbus master

4. Configure the meter’s other serial port parameters as required.

For Modbus mastering, you must add the Modbus slave devices using ION Setup.

See your device’s Modbus map, available from www.schneider-electric.com for Modbus register information.

Related Topics

- Configuring your meter as a Modbus master using ION Setup

Supported Modbus features

Your meter supports specific Modbus data classes, data formats, function codes and commands.

Modbus data classes

Class	Description
Coils	Digital bits that can be read and written to
Input status	Digital bits that can be read
Input registers	16-bit integers that can be read
Holding registers	16-bit integers that can be read and written to

Modbus data formats

Format	Type	# of Modbus registers used
Unsigned 16-bit	Integer	1
Signed 16-bit	Integer	1
Unsigned 32-bit	Integer	2
Signed 32-bit	Integer	2
Unsigned 32B-M10K	Integer	2
Signed 32B-M10K	Integer	2
IEEE float ¹	Floating point	2
Packed Boolean for inputs	Integer	1
Packed Boolean for coils	Integer	1
Unsigned 16-bit read/write	Integer	1
Signed 64 bit	Integer	4

¹ Meters acting as Modbus masters support two versions of IEEE float with different word orders: high/low = Big Endian, low/high = Little Endian.

16-bit data (one word) is transmitted with most-significant byte first and least-significant byte second.

32-bit data (two words) is transmitted with the most-significant word first and the least-significant word second.

Modbus function codes

Function	Description	Master/slave
1	Read coil status	Master and slave
2	Read input status	Master and slave
3	Read holding registers	Master and slave
4	Read input registers	Master
5	Write to a coil	Master
6	Write to a holding register	Master and slave
15	Write to multiple coils	Master
16	Write to multiple holding registers	Master and slave
17	Report slave ID (serial only)	Master and slave

Function	Description	Master/slave
43 (subcode 14)	Read device identification	Master and slave
100	Read scattered holding registers	Master and slave

Modbus commands

A Modbus master command to unit ID 0 is broadcast (sent to) all Modbus slave devices. The only supported broadcast command is preset multiple registers.

For serial Modbus networks with only one slave device, the master can send commands using the single connection, one-to-one address of unit ID 248, regardless of the slave device's actual unit ID.

Modbus implementation

Your meter's Modbus implementation includes exception codes, invalid register responses, fixed and configurable register maps, and security.

Modbus exception codes

Code	Name	Description
01	Illegal function	The requested command is invalid.
02	Illegal address	This code indicates one of the following: <ul style="list-style-type: none"> The requested address is invalid for that function. The requested address is not within the valid register range for this device. The requested address is protected by device security.
03	Illegal value	This code indicates one of the following: <ul style="list-style-type: none"> The requested value is not allowed for that register in the device. The requested register is part of a multi-word value.

Modbus invalid read registers responses

Invalid type	Read response
Unmapped (unused) ¹ register	0x8000
Reserved ¹ register responses by type	
Signed integer 16-bit	0x8000
Unsigned integer 16-bit	0xFFFF
Signed integer 32-bits	0x80000000
Unsigned integer 32-bits	0xFFFFFFFF
Signed integer 64-bits	0x8000000000000000
Float32	0xFFC00000 (NaN = Not a number)

¹ IRIG-B can only be connected to one of the digital inputs located on the meter base, not an option module. Unmapped (unused) registers are registers that will never be used by the meter, and therefore have no defined format. Reserved registers have a defined format and are intended for use by the meter, its options or its variants.

Modbus invalid write registers response

If the meter receives a write command to a Modbus register address that does not have a register mapped, the meter does not respond. No data is written or stored, and the meter does not send back a rejection to the request.

If the meter receives a write command to a read-only Modbus register address, exception code 3 (illegal value) is returned.

Fixed and configurable Modbus map

Your device has a fixed (static) register map for meter data and a flexible, user-configured register map.

Modbus security

Your meter's onboard security options include Modbus-specific settings. These security settings may need to be configured in order to write Modbus data to the meter.

Modbus map

Your meter's default Modbus register information (map) is available for download from www.schneider-electric.com.

The Modbus register information includes:

- registers and mapped values
- formats and scaling
- additional details where applicable

NOTE: Your meter's Modbus registers are specified differently than previous devices using ION architecture. If you are configuring Modbus slave information on your meter, confirm you are using the appropriate Modbus register addressing. Refer to your meter's Modbus map for more information.

Your meter has a fixed (static) register map which contains the most common metering values. This map is defined by a series of Data Mapping modules, which also determine the values shown on your device's display and webpages. The Data Mapping modules are named based on the type of information they map to Modbus:

Data Mapping module	Description
Data Mapping Dmd Modules	Maps kW, kVA and kVAR demand data such as kW sd del (sliding demand kilowatts delivered) as well as current demand such as I a sd (sliding demand phase A current).
Data Mapping Egy Modules	Maps kWh, kVAh and kVARh delivered and received data, including conditional, quadrant and incremental energies.
Data Mapping EN Modules	Maps present interval EN50160 power quality compliance data.
Data Mapping EN Prev Modules	Maps previous interval EN50160 power quality compliance data.
Data Mapping I/O Modules	Maps input metering data, alarms, resets and reset counts.
Data Mapping Meas Modules	Maps measured data from the standard and high-speed Power Meter module. The Cfg Modbus Map Enable setup register may exist in this module.
Data Mapping PQ Modules	Maps power quality data such as Crest Factor, K Factor and total harmonic distortion, including IEC 61000-4-30 power quality compliance data.
Data Mapping Stats Modules	Maps statistical low, mean and high data values, such as I a mean (phase A current average value).
Data Mapping TOU Modules	Maps time-of-use (TOU) data, such as seasons, rates, and per-season demand such as kW sd rec A (sliding demand kilowatts received in season A).

You can add extra Modbus information or duplicate information that is already in the fixed map to different Modbus registers using Modbus Slave modules.

See the ION Reference available from www.schneider-electric.com for detailed information about Data Mapping modules and Modbus Slave modules.

Configuring custom Modbus data using ION Setup

You can add custom data to your meter's default Modbus map, completely customize your meter's Modbus map, or revert your meter's Modbus map back to its default configuration using ION Setup.

You can download your meter's Modbus map information from www.schneider-electric.com.

1. Start ION Setup.
2. Open the Setup Assistant for your meter.
3. Navigate to **Communications > 3rd party protocols** and click on the **Modbus Slave** tab.
The name of the meter's current Modbus map is displayed, along with the quantity of custom registers and their start and end addresses.
4. Select the map name and click **Edit**.
The **Modbus Slave Mode Setup** screen is displayed.
5. Select your meter's method of Modbus slave mapping. If you select **Default** or **Disabled**, click **Finish** to configure your meter and return to the Setup Assistant, otherwise select **Next** to access the **Modbus Slave Map Setup** screen.

Option	Description
Default	Sets your meter to use the default Modbus map. Any custom Modbus slave data is removed. NOTE: You can download your meter's Modbus map information from www.schneider-electric.com .
Modified	Add Modbus information in addition to the meter's default Modbus map.
Custom	Removes the meter's default Modbus map so that all registers are available so you can create a completely custom Modbus map. NOTE: Use this option if you want to make your meter's Modbus map identical to a device that it is replacing, for example in a retrofit application.
Disabled	Removes your meter's Modbus data map. Modbus functions are unaffected but no meter Modbus data is available.

6. In the **Modbus Slave Map Setup** screen, you can modify parameters by clicking **Edit**, or add parameters by clicking **Add**.
The **Modbus Register** screen is displayed.
7. Configure the Modbus register information and click **OK** to return to the **Modbus Slave Map Setup** screen.
 - a. **Source:** click **Select** and chose a source from the **Parameter Selection** screen. Select **Show all available registers** to see a complete list of the parameters available on your meter. Click **OK**.
 - b. **Address:** enter the Modbus address that will hold the Source data.
NOTE: If you hover your mouse over the Address field, a tooltip indicates the Modbus function code and start address to send for retrieving the data.
 - c. **Format:** select the Modbus data format from the list.
 - d. **Scaling:** select the scaling value from the list, or select **Custom** and click **Scales** to configure custom scaling.

8. In the **Modbus Slave Map Setup** screen you can click **Delete** to remove a Modbus register, **Set Name** to create a new name for the set of additional data mapped to Modbus, or **Save As** to save the additional data you have mapped to Modbus as a separate file.
9. Click **Finish** to complete your meter's Modbus slave configuration and return to the Setup Assistant.

Ethernet gateway

Ethernet gateway is a communications method that allows you to communicate through a gateway device to a serial network.

When a meter with gateway capabilities is installed on an Ethernet network, a master device (such as an energy management system) can communicate through the gateway meter to a serial network of devices connected to the gateway meter's serial port(s). The maximum number of devices on the serial network is determined by the limitations of the gateway meter's serial port.

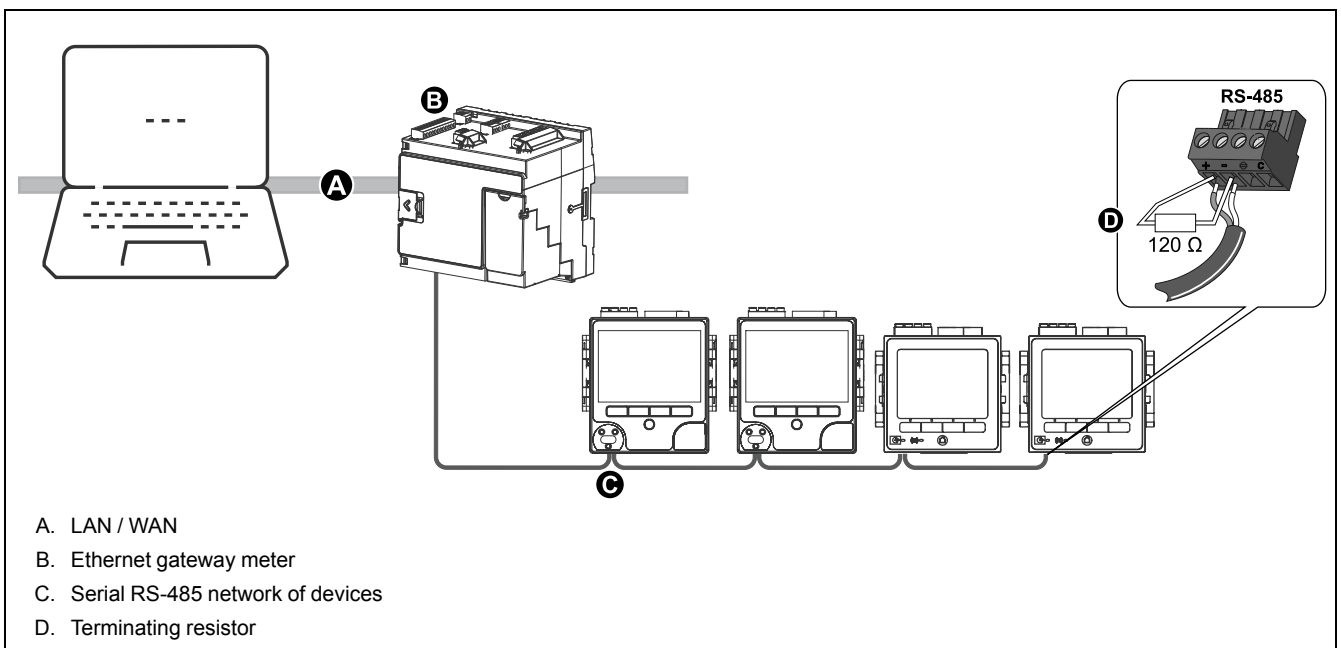

There are two types of Ethernet gateways that you can configure on your meter:

- EtherGate: a single TCP connection communicates through the gateway meter to a serial network of devices.
- Modbus gateway: up to a maximum of 32 Modbus master TCP connections communicate through the gateway meter to a serial network of Modbus devices.

EtherGate

The meter can function as an Ethernet gateway (EtherGate).

EtherGate is a protocol-agnostic communications method that lets you communicate through a gateway meter to a serial network of devices letting ION or other RTU over TCP data pass through the gateway meter to other networks, including third party systems. When a meter installed on the Ethernet network has EtherGate enabled, a master device (such as an energy management system) can communicate through the gateway meter to a serial network of devices wired to the gateway meter's COM port. You must create an additional communications connection to the gateway meter in order to read its information.

NOTE: EtherGate supports only one master device.

Before proceeding, make sure you have completed the following tasks:

- Confirm the serial network of devices are wired to the gateway meter’s serial communication port.
- Confirm all serial devices are configured to have the same baud rate, serial port settings (for example, 8N1), and protocol (ION).
- Confirm each serial device has a unique unit identifier (unit ID/address).
- Confirm your gateway meter is communicating over Ethernet.

Configuring EtherGate using ION Setup

Use ION Setup to configure EtherGate communications on your meter.

1. Start ION Setup.
2. Open the Setup Assistant for your meter.
3. Navigate to **Communications > Serial settings**. Select the tab (Com1 or Com4) for the serial port you want to configure.
4. Highlight the parameter and click **Edit**. Enter the meter password if prompted, change the setting, then click **OK** to save the changes.

Parameter	Setting
Protocol	EtherGate
Baud Rate Serial Port	Serial port settings must match the settings for all connected serial devices

5. Create an Ethernet gateway site to access the serial network of devices through your gateway meter.

Related Topics

- Creating an Ethernet gateway site using ION Setup

Configuring EtherGate using the webpages

You can use the meter webpages to configure EtherGate communications on your meter.

1. Connect to your meter’s webpages.
2. Navigate to **Setup > Serial Port**.
3. Expand Basic Settings or Advanced Settings and modify the settings for the serial port you are configuring for EtherGate communications (**COM1 / RS485#1** or **COM4 / RS485#2**).
4. Change the settings, then click **Apply**. Click **Yes** to save the changes.

Parameter	Setting
Protocol	EtherGate
Baud Rate Serial Port	Serial port settings must match the settings for all connected serial devices

You can use ION Setup to create an Ethernet gateway site and access the serial network of devices connected through the EtherGate meter.

Related Topics

- Creating an Ethernet gateway site using ION Setup

Configuring EtherGate using the display

Use the meter’s display to configure a serial port to use the EtherGate protocol.

1. Press the **Home** button.
2. Navigate to **Setup Menu > Communications Setup**.
3. Press **Select**.
4. Scroll then select **COM1 Setup** or **COM4 Setup**.
5. Highlight the parameter and press **Edit**. Enter the meter password if prompted, change the setting, then press **Select** to save the changes.

Parameter	Setting
Protocol	EtherGate
Baud Rate Serial Port	Serial port settings must match the settings for all connected serial devices

You can use ION Setup to create an Ethernet gateway site and access the serial network of devices connected through the EtherGate meter.

Related Topics

- Creating an Ethernet gateway site using ION Setup

Modbus Ethernet gateway

A Modbus Ethernet gateway allows multiple Modbus masters on the LAN / WAN to connect to downstream serial Modbus slave devices.

A Modbus master device, such as an energy management system, can communicate through the gateway meter to a serial network of devices connected to the gateway meter’s serial port(s). The meter receives Modbus TCP/IP data on TCP port 502, translates it to Modbus RTU then forwards it to the addressed slave device.

This functionality allows the use of monitoring software to access information from slave devices for data collection, trending, alarm/event management, analysis, and other functions.

Modbus Ethernet gateway implementation

There are some specific aspects to your meter’s Modbus Ethernet gateway implementation.

A Modbus request is sent through Ethernet using Modbus/TCP to the gateway meter. If this request is addressed with the slave ID of one of the downstream serial devices, the meter forwards the message to that device using Modbus RTU. When the downstream device responds, the gateway meter forwards the response back to the Modbus master. In addition to Modbus slave addresses 1 - 247, the Modbus gateway supports slave address 255, which sends a Modbus request to the gateway meter only.

For Modbus gateway, you must install the serial Modbus slave devices, configure them and connect them to your Ethernet-connected Modbus gateway meter. Ensure that each serial device is configured to communicate over Modbus with the same baud rate and has a unique unit ID. Configure the gateway meter’s serial port to use the Modbus master protocol and enable the Modbus gateway feature, create a Modbus gateway site in ION Setup or an energy management system, and add the serial devices to the Modbus gateway site.

NOTE: Modbus Ethernet gateway supports up to 32 Modbus TCP connections.

Configuring a Modbus gateway using ION Setup

You can configure Modbus gateway on your meter using ION Setup.

Before you begin, make sure you have completed the following tasks:

- Confirm the serial network of devices are wired and configured to have the same baud rate, serial port settings (for example, 8N1), and protocol (Modbus).
- Confirm each serial device has a unique unit identifier.
- Confirm the serial network of devices are connected to the gateway meter's serial communication port.
- Confirm your gateway meter is communicating over Ethernet.
- Confirm that the Modbus RTU and Modbus TCP/IP Ethernet protocols are enabled on your gateway meter.

1. Start ION Setup.
2. Open the Setup Assistant for your meter.
3. Navigate to **Communications > Serial settings** and select the tab for the communications port that the serial network is connected to.
4. Select **Protocol** and click **Edit**.
The protocol selection screen appears.
5. Set the protocol to **Modbus Master**.
6. Navigate to **Communications > Basic Ethernet** and select the **TCP/IP** tab.
7. Select **Modbus Gateway** and click **Edit**.
The Modbus gateway selection screen is displayed.
8. Select the communications port that the serial network is connected to (and you just set to use the Modbus master protocol) and click **OK**. The Modbus gateway connection is created.
9. Create an Ethernet gateway site to access the serial network of devices through your gateway meter.

Creating an Ethernet gateway site using ION Setup

You can create an EtherGate or Modbus gateway site in ION Setup to view serial devices connected to your meter when it is functioning as an Ethernet gateway.

You must have Ethernet gateway communications configured and your gateway and serial devices connected and communicating.

1. Start ION Setup.
2. Right-click on your workstation icon and select **Insert Item**.
The **New Network Item** dialog appears.
3. Select **Site** and click **OK**.
The **New Site** dialog appears.

4. Select the **General** tab and configure the site.

Parameter	Values/Options	Description
Name	-	Ethernet gateway site name
Comm Link	Ethernet	Ethernet communications
Ethernet options	Gateway	Ethernet gateway communications
Gateway Info: IP Addr	—	IP address of the Ethernet gateway meter
Gateway Info: Port	7801, 7802, 502	<ul style="list-style-type: none"> • 7801 for EtherGate (Com1) • 7802 for EtherGate (Com4) • 502 for Modbus gateway

5. Click **OK** to create the site.
6. Right-click on your newly created site and select **Insert Item**. The **New Network Item** dialog appears.
7. Make sure your newly created Ethernet gateway site is selected in **Attach to**.
8. Select **Device** and click **OK**. The **New Device** dialog appears.
9. Enter the details of your serial device. Click **OK** to add the serial device to your Ethernet gateway site.
10. Repeat for all the serial devices on the gateway meter.

NOTE: Use a separate standard Ethernet connection in ION Setup to connect to and read data from your Ethernet gateway meter.

HTTP

HTTP (HyperText Transfer Protocol) is the standard protocol used by a web browser to establish communication between a client computer and the meter's web server.

You can view the meter's webpages by entering the meter's IP address on a web browser.

HTTP is not a secure communications protocol. To reduce the risk of security threats and help prevent unauthorized access to the meter and the network, configure the meter to always use HTTPS (HyperText Transfer Protocol Secure). The meter uses Ethernet port 80 for HTTP or port 443 for HTTPS.

HTTPS

HTTPS uses Transport Layer Security (TLS) encryption to secure the communications channel and protect exchanged data between the client and the server. When configured to use HTTPS, the meter uses the self-signed certificate installed on its webserver.

Changing HTTP protocol using ION Setup

You can change the protocol setting for accessing the meter webpages.

It is recommended to use **HTTPS** or **HTTPS with HTTP redirect** to avoid compromising the security of your local network.

1. Start ION Setup.

2. Open the Setup Assistant for your meter.
3. Navigate to **Communications > Advanced Ethernet** and click the **Protocols** tab.
4. Select the **Web** protocol and click **Edit**. If prompted, enter the meter password.
5. Select the web protocol setting:

Option	Description
Disabled	Turns off the meter's web functionality and blocks all access to the meter web server
HTTP	Allows non-secure access and unencrypted communications between the client computer and the meter web server
HTTPS	Allows only secure access and encrypted communications between the client computer and the meter web server
HTTPS With HTTP Redirect	Redirects all HTTP requests to use the HTTPS web protocol.

You can change the default Assigned Port Numbers for **HTTP** and **HTTPS**. This requires appending the changed port number for HTTP or HTTPS access to the meter's webpages. For example, <meter IP address>:<changed http or https port number>.

Secure website indicator

A secure website displays a visible indicator such as a lock icon on the web browser.

The web address prefix `https://` also indicates that the website is secure.

Web browsers typically prompt or display a message to warn you if a website you are trying to access is not secure. For https connections, this indicates that the website's SSL certificate is not configured properly or is missing.

Default SSL certificate and webpages security

The meter web server protocol is factory-set to HTTPS with HTTP Redirect.

The meter ships from the factory with a self-signed certificate installed, and is set to use HTTPS protocol when accessing the webpages. Because the SSL certificate is self-signed and not signed by a trusted Certificate Authority (CA), almost all browsers will flag the webpages as unsafe.

- If your meter is accessible only inside a secure network, you can add a security exception to override how the browser identifies the webpages.
- If your meter is outside a secure network, you can install a SSL certificate issued by a CA.

Uploading a custom SSL certificate

You can upload a custom SSL certificate through the meter webpages. Your meter supports .pem certificate file formats.

1. Use a browser to log in to your meter.
2. Navigate to **Setup > HTTPS**.
3. Click **Upload certificate**.
4. Browse to where you saved the custom certificate, select it then click **Open**. The certificate is uploaded to the meter, then the browser session is restarted.

Generating a new self-signed SSL certificate

You can generate a new self-signed certificate through the meter webpages. A self-signed certificate is valid during the lease period. Generating a new certificate renews the lease.

1. Use a browser to log in to your meter.
2. Navigate to **Setup > HTTPS**.
3. Click **Generate new self-signed certificate**.
The meter prompts that the custom certificate will be deleted and that you will be logged out.
4. Click **OK** to proceed.

Deleting a custom SSL certificate

You can delete a custom certificate through the meter webpages.

1. Use a browser to log in to your meter.
2. Navigate to **Setup > HTTPS**.
3. Click **Delete custom certificate**.
The meter prompts that you will be logged out and that a self-signed certificate will be used.
4. Click **OK** to proceed.

FTP

Your meter has an internal FTP server that you can use to load files, such as custom webpages, and upgrade your meter and meter accessories.

FTP (File Transfer Protocol) is a standard, client-server network protocol used to transfer files over Ethernet networks.

Accessing your meter's FTP server

You must have FTP software such as Filezilla, WinSCP or Windows Explorer running on a Windows-based machine to transfer files to and from your meter's internal FTP server.

1. Start your FTP software.
2. Connect to your meter via FTP by entering your meter's IP address.
Depending on your FTP software and meter security settings, you may be prompted for login credentials.
NOTE: With standard meter security (no user configured), enter login credentials of 9000 and the meter password to connect to the meter. For advanced meter security, enter a valid user and password.
3. Navigate to the appropriate folder on your meter.
4. Close your FTP software to disconnect from the meter. The FTP connection automatically disconnects once the FTP timeout period has elapsed.

FTP memory allocation

Your meter's FTP memory usage changes when you copy a file to the meter's internal FTP site or modify a feature that uses the meter's FTP site.

If you attempt to load a file onto your meter’s FTP site that is too large, your FTP program displays an error, and you must delete files from your meter’s internal FTP site to free up memory before loading the file.

If you modify a meter feature which uses FTP memory, such as increasing the number of COMTRADE waveform records, the meter checks to confirm sufficient space is available on its internal FTP site before enabling the modified feature. If there is insufficient space, the feature is disabled, and you must delete files from your meter’s FTP site to increase the available space before enabling the feature.

FTP file structure and permissions

Your meter has an FTP folder structure.

- COMTRADE: you can read COMTRADE files from these folders, but you cannot delete or add files to these folders.
- IEC61850: you can add an IEC 61850 configuration (CID) file to this folder to activate the IEC 61850 protocol functions of your meter.
- optionModuleUpg and rmdUpg: you can load firmware update files for your meter’s remote display or option modules into these folders.
- documents: this folder is intended for user storage. You can read, write and delete any type of files in this folder.
- web: this folder is where the meter’s default webpages are stored and where you can add custom webpages to the meter by copying them into the appropriate subfolders.

FTP filename requirements

FTP filenames are limited to standard ASCII characters.

This means that they cannot contain a blank space, quotation marks or \, /, *, ?, < or >, and are limited to 68 characters in length, including the file extension. The “/” character is only used as part of the FTP file directory information.

Simple Network Management Protocol (SNMP)

Your meter supports SNMP once you have enabled SNMP on your meter. You need to upload the meter’s MIB file (available from www.schneider-electric.com) into the NMS managing your meter.

Simple Network Management Protocol (SNMP) is part of the Transmission Control Protocol/Internet Protocol (TCP/IP) protocol suite. SNMP is an application layer protocol that enables the exchange of network management information between devices, allowing you to manage network performance and to identify and solve problems on networks with devices of various types.

SNMP configuration assumes that you have an advanced understanding of SNMP and the communications network and power system that your meter is connected to.

Key terms

Term	Definition
Agent	Software resident on the managed device which interfaces between the device and the NMS.
Managed device	Your meter in the SNMP network.
Community name/string	A text string that helps authenticate requests between the managed device and the NMS.
Managed object	Any parameter referenced in the MIB file.
MIB	A management information base which organizes the OIDs in a hierarchical tree.

Term	Definition
NMS	A network management station, manager or client that executes applications to monitor and control devices. An NMS must have the standard and custom MIB files and SNMP manager software.
OID	An object identifier that uniquely identifies and labels a managed object in the MIB.
Trap receiver	An NMS that is configured to receive traps and whose IP address is an SNMP trap destination.

The meter in an SNMP system

Your meter is a managed device with an SNMP agent in an SNMP network.

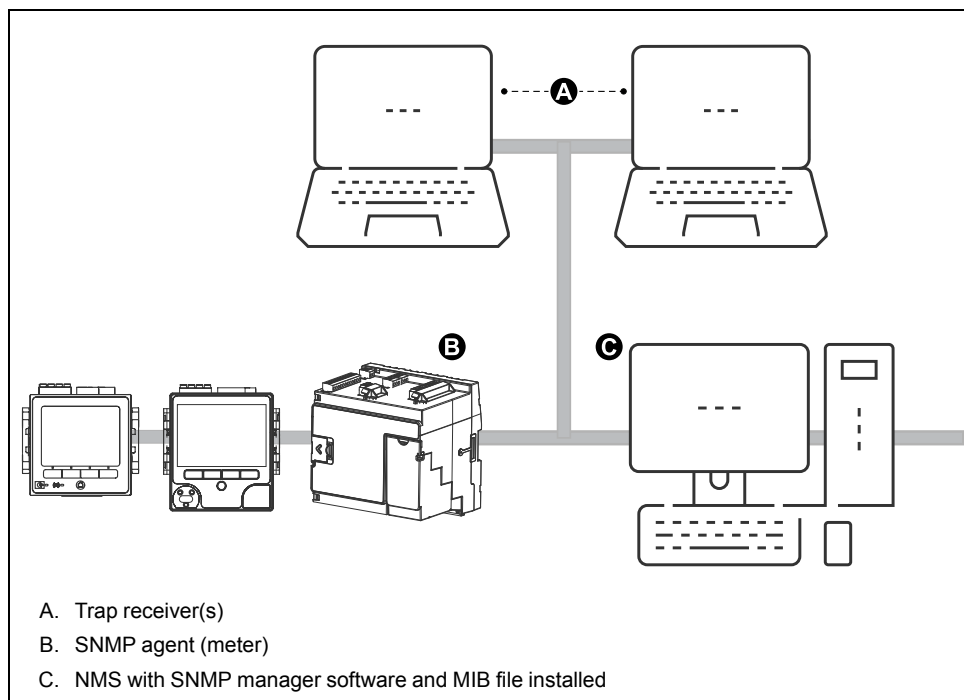

NOTE: The NMS computer can also function as a trap receiver.

SNMP trapping

SNMP trapping allows your meter’s agent to notify the NMS of events with an unsolicited SNMP message (a “trap” of the meter’s alarm event).

You can enter up to four IP addresses for SNMP trap notification for generic and enterprise-specific traps. For enterprise traps, you must also define the number of events or maximum time delay before SNMP traps are sent to the NMS.

SNMP trapping is only supported on SNMP v2.

Configuring SNMP using ION Setup

You can enable SNMP and configure SNMP trapping using ION Setup.

You must download the ION MIB file from www.schneider-electric.com

1. Start ION Setup.
2. Open the Setup Assistant for your meter.
3. Navigate to **Communications > Advanced Ethernet** and select the **SNMP** tab.

- Configure your meter’s SNMP parameters by selecting the parameter and clicking **Edit**. Click **OK** in the editing screen to set the parameter value.

Parameter	Description
Enable SNMP	Enables or disables SNMP on your meter.
Enable Traps	Enables or disables SNMP trapping on your meter.
Trap Rcvr Addr1 — Trap Rcvr Addr4	Enter up to four trap receiver IP addresses where trap messages will be sent.
Read only community	Enter the community string used for SNMP get (read-only) requests.
Read write community	Enter the community string used for SNMP set (read/write) requests. NOTE: You can use the read/write community string for SNMP get (read-only) requests.
System contact	Enter the name of your SNMP system administrator.
System name	Enter a descriptive name for your meter.
System location	Enter your meter’s location.

- Review the rest of the SNMP information and modify if necessary.

Configuring SNMP using your meter’s webpages

You can configure SNMP trapping using your meter’s webpages.

You must download the ION MIB file from www.schneider-electric.com.

- Connect to your meter’s webpages.
- Go to **Setup > SNMP Parameters**.
- Configure your meter’s SNMP parameters by selecting the parameter value.

Parameter	Range	Description
Enable SNMP .	Yes/no	Enables or disables SNMP on your meter.
SNMP Port Number	161 (default)	Enter your meter’s SNMP port number.
System contact	—	Enter the name of your SNMP system administrator.
System name	—	Enter a descriptive name for your meter.
System location	—	Enter your meter’s location.
Read-only Community Name	—	Enter the community string used for SNMP get (read-only) requests.
Read-write Community Name	—	Enter the community string used for SNMP set (read/write) requests. NOTE: You can use the read/write community string for SNMP get (read-only) requests.
Enable SNMP Traps	Enable/disable	Enables or disables SNMP trapping on your meter.
Enable High Priority Alarms	Yes/no	Enables trapping of events that create high priority alarms.
Enable Med Priority Alarms	Yes/no	Enables trapping of events that create medium priority alarms.
Enable Low Priority Alarms	Yes/no	Enables trapping of events that create low priority alarms.
Report Buffer Size	1 - 30	Enter the maximum number of trap messages to be stored before the trap messages are sent. Traps are sent when the number of trap messages is equal to or greater than this value.
Report Hold Time	1 - 300 seconds	Enter the maximum duration for trap messages to be held. Trap messages are sent when the time after a trap event has occurred is equal to or greater than this value.
Trap Rcvr1 Addr - Trap Rcvr4 Addr	—	Enter up to four trap receiver IP addresses, where trap messages will be sent.

- Click **Apply** to configure the meter’s SNMP parameters.

SNMP implementation

MIB files

Your meter is compliant with MIB-II as defined by the standard MIB file RFC 1213.

SNMP requires that you load your meter's ION MIB file (available for download from www.schneider-electric.com) into the NMS.

You must install RFC 1213, which is required to read basic network information for the meter (for example, TCP/IP traffic or number of packets received), if it is not included with your SNMP manager software.

Community strings

A community string is a text string which acts to help authenticate requests from the NMS to your meter.

There are two community strings on your meter:

- Read Only Community: this community string is used by SNMP get (read-only) requests. The read only community string's initial factory-set value is **public**.
- Read Write Community: this community string is used by SNMP set (read/write) requests. The read write community string's initial factory-set value is **private**.

NOTE: You can also use the read write community string for SNMP get (read-only) requests.

If your meter receives an incorrect community string, it generates an AuthenticationFailure trap.

System strings

A system string is a text string which can be configured to provide information about your meter.

There are three system strings on your meter:

- System contact: enter the name of the SNMP system administrator.
- System name: enter a descriptive name for your meter.
- System location: enter a description of your meter's location.

SNMP trapping implementation

Generic SNMP traps supported by your meter are:

- Coldstart: the meter (SNMP agent) is starting.
- Linkup: the SNMP agent is enabled.
- AuthenticationFailure: the meter (SNMP agent) has received an incorrect community value.

Enterprise-specific SNMP traps supported by your meter are:

- Low: trap of events with a low event priority.
- Medium: trap of events with a medium event priority.
- High: trap of events with a high event priority.

Trap	Event priority range
Low	64–127
Medium	128–191
High	192–255

NOTE: The number of events or maximum time delay settings only apply to enterprise SNMP traps.

See the ION Reference, available from www.schneider-electric.com, for detailed information on the SNMP Mapping, SNMP Options and Alarm Options modules.

Default SNMP mapping

Enabling SNMP provides SNMP access to the meter values linked to the SNMP Mapping module.

You can configure the SNMP Mapping module to link to different meter values. By default, the following meter values are linked to the SNMP Mapping module:

I a	kVAR tot	VII ca	VIn avg	Ib mean	kW sd mx del-rec
I b	kVA tot	VII avg	Freq	Ic mx	kW sd del
I c	PF sign tot	VIn a	Ia mx	Ic mean	kW sd rec
I avg	VII ab	VIn b	Ia mean	kW sd mx del	kW sd del-rec
kW tot	VII bc	VIn c	Ib mx	kW sd mx rec	kVAR sd mx del
kVAR sd mx rec	kVAR sd mx del-rec	kVAR sd del	kVAR sd rec	kVAR sd del-rec	kVA sd mx del
kVA sd mx rec	kVA sd mx del-rec	kVA sd del	kVA sd rec	kVA sd del-rec	kWh del
kWh rec	kWh del-rec	kVARh del	kVARh rec	kVARh del-rec	kVAh del
kVAh rec	kVAh del-rec				

The following meter information is always provided by default and cannot be configured:

Voltsmode	Model number
Serial number	Device name
Firmware version	MIB version

If you change your meter’s default values you must modify the custom MIB file to reflect the new values.

Changing your meter’s default SNMP configuration assumes that you have an advanced understanding of ION architecture, SNMP, and the communications network and power system that your meter is connected to.

See the ION Reference, available from www.schneider-electric.com, for detailed information on the SNMP Mapping module.

Configuring your SNMP MIB file

You must configure your MIB file if you have modified the default SNMP information provided by the meter in order for the MIB file labels to reflect the modified values.

Download the ION MIB file from www.schneider-electric.com.

NOTE: You should only configure the variable name and description. Changing other fields in your MIB file may cause the client software to report problems or return errors when trying to retrieve or view parameters.

The variable name must conform to the following rules:

- The first character must be a letter.
- The first character must be lower case.
- The name must not contain any special characters such as *, ?, &.
- The name must not contain spaces.

1. Open your meter’s MIB file in a text editing program (such as Notepad).
2. Update the variable name and description so they match the meter values connected to the SNMP Mapping module.

3. Save your meter’s MIB file. Make sure you keep the original file extension of .MIB.

This example shows an original and an updated OID entry in an MIB file, where the default meter value of voltage line-to-neutral phase A is modified in the meter’s SNMP Mapping module and is now connected to voltage line-to-neutral phase C.

Original OID entry
Vln_a OBJECT-TYPE SYNTAX DisplayString (SIZE (0..255)) ACCESS read-only STATUS mandatory DESCRIPTION "Host Meter Voltage Line A to Neutral Units = V (Volts)" ::= { Schneider Electric 34 }

You must update the variable name and description to match the meter values connected to the SNMP Mapping module:

Value	Original	Updated
Variable name	Vln_a	Vln_c
Description	"Host Meter Voltage Line A to Neutral Units = V (Volts)" ::= { Schneider Electric 34 }	Host Meter Voltage Line C to Neutral Units = V (Volts)" ::= { Schneider Electric 34 }

The SNMP client software reads the original and updated file as follows:

Original	Updated
variable name: Vln_a Description: "SNM1 Input 1 - Voltage (line-to-neutral) phase A"	variable name: Vln_c Description: "SNM1 Input 1 - Voltage (line-to-neutral) phase C"

IEC 61850

IEC 61850 is an Ethernet-based protocol designed for electrical substations.

It is a standardized method of communications, developed to support integrated systems composed of multi-vendor, self-describing IEDs (intelligent electronic devices) that are networked together.

Your meter can be integrated into an IEC 61850 system as an IED (or server) supporting concurrent IEC 61850 client connections and an FTP connection (used for transferring data or configuration files).

You can go to the IEC (International Electrotechnical Commission) website at www.iec.ch for information about the IEC 61850 protocol. For more information on how IEC 61850 is implemented on your meter, see the *IEC 61850 and ION Technology* protocol document.

IEC 61850 implementation

Your meter comes configured with a default set of meter data available to IEC 61850.

This default set of meter data is used in the default data sets and reports in the ICD file(s) available for download from www.schneider-electric.com.

NOTE: Select the ICD file that matches your meter’s option module configuration.

You must load a valid IEC 61850 configuration (CID) file into the meter’s internal FTP site in order to activate the IEC 61850 features of your meter. Your meter can have only one IEC 61850 configuration (CID) file loaded onto its internal FTP storage. If additional CID files are loaded, IEC 61850 functions are deactivated until the additional files are removed.

NOTE: IEC 61850 is not supported over IPv6.

You can load the IEC 61850 configuration file and configure the IEC 61850 custom modules using ION Setup.

Related Topics

- FTP

Loading an IEC 61850 configuration file using ION Setup

You can load an IEC 61850 configuration (CID) file using ION Setup over an Ethernet connection.

You must have:

- The IEC 61850 configuration file stored in a location accessible by ION Setup. The configuration file is created by customizing the IEC 61850 device (ICD) file, which can be downloaded from www.schneider-electric.com.
- FTP access to your meter from the computer running ION Setup.

NOTE: Your meter can have only one IEC 61850 configuration (CID) file loaded onto its internal FTP site. If additional CID files are loaded, IEC 61850 functions are deactivated until the additional files are removed.

1. Start ION Setup.
2. Open the Setup Assistant for your meter.
3. Navigate to **Communications > 3rd Party Protocols** and select the **IEC 61850** tab.
4. Highlight a parameter and click **Upload**. Navigate to where you stored your meter's CID file, select the file, and click **Open**.

Your meter reviews the CID file to determine if it is valid. This process may take several minutes.

The CID status indicates whether the meter has received and validated an IEC 61850 CID file and is operating as an IEC 61850 server.

Configuring additional data for IEC 61850 using ION Setup

You can map additional data to IEC 61850 using ION Setup.

You must have a valid IEC 61850 configuration file loaded onto your meter for IEC 61850 functionality, but it is not necessary for configuring additional data.

NOTE: You can configure additional data at any time, whether or not IEC 61850 is operating on your meter.

1. Start ION Setup.
2. Open the Setup Assistant for your meter.
3. Navigate to **Communications > 3rd Party Protocols** and select the **IEC 61850** tab.
4. Select the information type that corresponds to the type of meter information that you want to add to your IEC 61850 data. Select analog for numeric information and digital for boolean or binary information. Click **Edit**. The custom configuration screen is displayed.
5. Select the desired meter value from those available. If the value you want is not shown, select **Show all available registers**.
6. Select an IEC 61850 leaf to associate with the meter data:
 - Click **>>** to map the value.
 - Click **<<** to unmap values.

7. Click **OK** to send and save your changes to the meter.

Configuring digital outputs for IEC 61850 control using ION Setup

You can configure your digital outputs so that they can be used for non-critical control via IEC 61850.

Your meter has a comprehensive default implementation of IEC 61850 which meets the needs of most systems with only basic configuration. You can customize this implementation so that IEC 61850 can be used to control your meter's digital outputs; this is an advanced procedure that requires in-depth knowledge of your meter, its underlying architecture, and the system in which it is installed.

▲ WARNING

UNINTENDED OPERATION

Do not use this device for critical control or protection applications where human or equipment safety relies on the operation of the control circuit.

Failure to follow these instructions can result in death, serious injury, or equipment damage.

1. Start ION Setup.
2. Connect to your meter in advanced mode.
3. Navigate to the GGIO Onboard folder and double-click on the module in the righthand pane.
4. Select the **Setup Registers** tab.
5. Select the *SPCS Control Mode* register that corresponds to the digital output you want to control through IEC 61850 and click **Edit**. A dialog appears.
6. Select IEC 61850 CTLVAL from the dropdown list and click **OK**.
7. Select the **Inputs** tab.
8. Select the digital output Status register for the digital output that you want to control through IEC 61850. Click **Delete**.
NOTE: This digital input register must be deleted in order to prevent a circular reference that will cause the affected modules to go offline.
9. Click **Send** to send your changes to the meter.
10. Navigate to the Digital Output folder. In the righthand pane, double-click on the module you have selected to control via IEC 61850.
11. Select the **Setup Registers** tab and confirm that the Digital Output module's setup registers are appropriately configured.
12. Select the **Inputs** tab.
13. Select the *Source* register and click **Edit**.
14. Navigate to the IEC 61850 GGIO Onboard folder and select the *SPCS.stVal* output register that corresponds to the digital output.
15. Click **OK** and **Send** to save your changes to the meter.

See the ION Reference, available from www.schneider-electric.com, for information about the IEC 61850 GGIO and Digital output modules.

DNP

Your meter can be integrated into a DNP network as a DNP slave.

The Distributed Network Protocol Version 3.0 (DNP 3.0) is an open protocol used in the electric utility industry for communications and interoperability among substation computers, Remote Terminal Units (RTUs), Intelligent Electronic Devices (IEDs, e.g. meters), and master stations.

DNP supported features and default implementation

Your meter is pre-configured for basic DNP Slave functionality.

Your meter supports a maximum of three concurrent connections (sessions) using the DNP 3.0 protocol; one for each serial port, up to three using Ethernet, or a combination of both. Combinations available depend on the meter's communications options. A session consists of all incoming and outgoing DNP Master/Slave traffic on one of the meter's communications ports.

For serial DNP communications, you must assign the DNP protocol to the appropriate serial communication port on your meter; you do not have to configure your meter's Ethernet port(s).

You can modify your meter's default DNP map using configuration software.

Data can be imported into the meter from a DNP control relay or analog output device. This is an advanced feature intended for users with an in-depth understanding of the DNP 3.0 and ION protocols.

See the online ION Setup help for instructions on connecting to your meter and accessing the Setup Assistant, which can be used to modify your meter's DNP port settings and default DNP map. Go to www.schneider-electric.com to download your meter's DNP 3.0 device profile document for detailed information on your meter's default DNP map and implementation and the *Multiport DNP 3.0 and ION technology* technical note for more information on how your meter supports DNP 3.0.

DLMS/COSEM

The Device Language Message Specification (DLMS) is described by the international standard IEC 62056. It defines structured modeling and meter data exchange for an interoperable environment.

DLMS supports applications such as remote meter reading, remote control, and value-added services for metering different kinds of energy, such as electricity, water, gas or heat.

COSEM stands for Companion Specification for Energy Metering. It is an interface model for communicating with energy metering equipment, providing a view of the functionality available through the communications interfaces. The model uses an object-oriented approach.

The COSEM model allows for a manufacturer-independent and controlled method to identify, retrieve and interpret the information held in any meter.

See the *DLMS/COSEM and ION technology* technote for more information about how DLMS is implemented on your meter.

Inputs / outputs

I/O overview

Your meter has onboard digital I/O which can be increased by adding optional digital and analog I/O modules to expand your meter's I/O capabilities.

⚠ WARNING

UNINTENDED OPERATION

Do not use the meter for critical control or protection applications where human or equipment safety relies on the operation of the control circuit.

Failure to follow these instructions can result in death, serious injury, or equipment damage.

Your meter base has:

- eight digital inputs
- four form A digital outputs
- two form C relays
- kWh energy pulsing LEDs (one visible, one infrared)
- kVARh energy pulsing LEDs (one visible, one infrared)

You can view information about your meter's I/O through the display and webpages, and configure your meter's I/O using ION Setup.

Input/output ION modules

ION modules are used to configure your meter's digital or analog inputs/outputs (I/O).

You need to configure the following ION modules in order to use the meter's digital or analog I/O.

- Digital input: uses the Digital Input module, which tells the meter how to interpret incoming signals.
- Digital output: uses one of three ION modules depending on the application.
 - Digital Output module: monitors a change of state to control relay operation via a hardware output device.
 - Pulser module: transfers high-speed pulses to a hardware pulse counting device that is used to track energy usage.
 - Calibration Pulser module: integrates instantaneous power inputs, then outputs high-speed pulses to an LED that can be monitored for energy accuracy verification.
- Analog input: uses the Analog Input module, which tells the meter how to interpret an incoming analog voltage or current signal from transducers.
- Analog output: uses the Analog Output module to deliver a continuous direct voltage or current analog signal to transducers.

NOTE: All of these modules can act as intermediaries between the physical hardware port and the other modules in the meter. They define the characteristics of the incoming and outgoing signals.

Input/output ION modules, ports and labels

You can configure the Digital Output, Digital Input, Analog Input, Analog Output, Pulser and Calibration Pulser ION modules to specify which port handles the outgoing or incoming signals.

To assign a port to one of these modules, simply modify the *Port* setup register by picking a port from the enumerated list.

NOTE: If the port you want to use does not appear in the *Port* setup register list, that port is in use by another module. Edit the *Port* setup register of the module using that port and set it to Not Used. The port is then available to other modules.

Factory configured settings

Onboard input and output ports

ION module type	ION module name	Hardware port (device label)	Port setup register name	Description
Digital Output	Port D1 – D4	D1 – D4	Port D1 – D4	Form A relay
	Port R1 – R2	R1 – R2	Port R1 – R2	Form C relay
Calibration Pulser	WATT LED	kWATT	WATT LED	kWatt energy pulsing (total)
	VAR LED	kVAR	VAR LED	kVAR energy pulsing (total)
Digital Input	Port S1 – S8	S1 – S8	Port S1 – S8	Internally/ externally excited

Option module(s) input and output ports

ION module type	ION module name	Hardware port (device label)	Port setup register name	Description
Digital Input	Port A/B/C/D S1 - S6	S1 - S6	Port A S1 - S6 Port B S1 - S6 Port C S1 - S6 Port D S1 - S6	Option module digital inputs
Digital Output	Port A/B/C/D D1 - D2	Relay 1 - Relay 2	Port A D1 - D2 Port B D1 - D2 Port C D1 - D2 Port D D1 - D2	Option module digital output
Analog Input	Port A/B/C/D A1 - A4	A1 - A4	Port A A1 - A4 Port B A1 - A4 Port C A1 - A4 Port D A1 - A4	Option module analog input
Analog Output	Port A/B/C/D Q1 - Q2	Q1 - Q2	Port A Q1 - Q2 Port B Q1 - Q2 Port C Q1 - Q2 Port D Q1 - Q2	Option module analog output

NOTE: When configuring your meter, the configuration interface may show all of the possible ports, regardless of what is physically available on your meter.

See the *ION Reference*, available from www.schneider-electric.com for more information about ION modules.

Related Topics

- Option modules

I/O option modules

I/O option modules provide increased digital and analog input/output (I/O) capabilities for your meter.

These I/O modules can be used to monitor the status of breakers, control analog or digital transducers, or receive signals that can be interpreted to provide WAGES

data for your energy system. For applications requiring high accuracy, such as energy pulsing to verify accuracy, the digital output on the meter base is recommended.

NOTE: Your meter's digital and analog outputs may change state during a firmware upgrade. Option modules are offline during an option module firmware upgrade; they will not communicate to the meter and the outputs may change state during the upgrade process.

Your meter's analog I/O option modules can measure and output either low voltage or current using standard analog transducers such as 4 - 20 mA current transducers.

I/O option module data viewing

View I/O option module data using ION Setup, meter webpages or through the display.

To view option module data using ION Setup, start ION Setup and open the Setup Assistant for your meter. Select **Expansion Modules > Option I/O Modules** then select the desired I/O option module tab. If there are no I/O option modules connected, no information other than column headers is displayed.

To view option module data using meter webpages, connect to your meter's webpages, go to **Monitoring > Inputs/Outputs** and select **Digital Inputs, Digital Outputs, Analog Inputs** or **Analog Outputs**. If there are no I/O option modules of the specified type, no entries other than column headers are displayed.

To view option module data using the display, go to **Inputs/Outputs** and select **Digital Inputs, Digital Outputs, Analog Inputs** or **Analog Outputs**.

Option I/O modules configuration

You can configure your meter's I/O option modules using ION Setup.

The Option I/O Modules screen has tabs corresponding to the possible option modules, which are identified based on how the option modules are connected to the meter. Each tab indicates the module's type and status, and has an area where the module's ports are listed for viewing and configuration. You can also reset your meter's option modules using ION Setup.

Status examples	Description
None	No option module detected
Normal	The option module is operating normally
Option module added	A new option module is detected
Option module removed	The option module has been removed
Invalid S19	The option module's firmware is not supported
Invalid card	The option module type is not supported

Related Topics

- Configuring option module analog inputs using ION Setup
- Configuring option module analog outputs using ION Setup
- Configuring option module digital inputs using ION Setup
- Configuring option module digital outputs using ION Setup

Analog inputs

Analog input applications

You can use an analog input to monitor an analog signal, for example a flowmeter, to monitor how much water flows through a pipe.

For analog input operation, your meter takes an analog input signal and provides the resulting scaled value.

Your meter’s analog I/O option modules can measure either low voltage or current using standard analog transducers such as 4 - 20 mA current transducers.

Related Topics

- Option modules

Analog input voltage and current mode

You can set the analog input’s mode for voltage or current sensing.

In current mode, the analog inputs have a low input resistance while the meter is powered on, and a high input resistance when the meter is powered off. In voltage mode, the analog inputs have a high input resistance regardless of whether the meter is powered or not.

NOTE: When unpowered, your meter’s analog inputs act like they are in voltage mode (high input resistance).

When connected to a current output transducer, this high resistance can create a high voltage. Standard (i.e., 4 to 20 mA) current transducers have open circuit protection and are able to handle a high input resistance; however, if non-standard transducers are used high voltages may be generated. Your meter’s analog input has circuitry to limit this voltage, but it may not be sufficient with a very high-power current source.

<i>NOTICE</i>
<p>EQUIPMENT DAMAGE</p> <ul style="list-style-type: none"> • Ensure the analog input is configured for the correct voltage or current mode before connecting or activating the current transducer. • Do not exceed the device’s ratings for maximum limits. <p>Failure to follow these instructions will result in equipment damage.</p>

Related Topics

- Option modules

Analog input behavior

Analog inputs may show a value below zero scale if an open circuit is detected on the input port.

Analog input zero scale and full scale values

Configure your analog input's zero and full scale values.

In most cases the output range of the sensor feeding the analog input matches the hardware limits of your meter's analog input port. In that case, the analog input's zero scale and full scale values are the same as the sensor's represented range. For example:

Analog sensor	Meter's analog input	Analog input values
0 - 50 psi represented by a 4 - 20 mA signal	4 - 20 mA analog input range	Full scale = 50 (psi) Zero scale = 0 (psi)

If the sensor's output range does not match your meter's hardware limits, you must calculate the full scale and/or zero scale values by analyzing the system.

See the ION Reference, available from www.schneider-electric.com, for detailed information about the Analog Input module and full scale and zero scale calculations.

Configuring option module analog inputs using ION Setup

You can configure analog inputs using ION Setup.

Analog inputs are available on the optional I/O modules.

Calculate your zero scale and full scale values based on the analog source and the input range of your meter.

Make sure that the analog input port that you want to use is properly configured and connected to a valid external analog signal source.

1. Start ION Setup.
2. Open the Setup Assistant for your meter.
3. Navigate to **Expansion Modules > Option I/O Modules** and select the module tab that corresponds to the option module with the analog input you want to configure.
4. Select the analog input channel and click **Edit**. Enter the meter password if prompted. The setup screen for that analog input is displayed.
5. Configure the analog input by selecting the parameter and clicking **Edit**.

Parameter	Value/Range	Description
Zero scale	0 to $\pm 10^9$	The minimum source value that matches the minimum analog input signal.
Full scale	0 to $\pm 10^9$	The maximum source value that matches the maximum analog input signal.
Port	–	The physical analog input port connection.
Mode	Voltage, current	Determines whether the analog input is monitoring voltage or current.
Update Rate	One Second/ High Speed	Defines how frequently the input is updated.

Related Topics

- Option I/O modules configuration

Analog outputs

Analog output applications

You can use an analog output to send a signal to an external analog input, for example an analog-controlled valve, to modify a water pipe’s valve position in order to change the flow rate.

For analog output operation, your meter takes an input value and scales it to the appropriate signal value to send out the physical analog output port.

Your meter’s analog I/O option modules can output either low voltage or current using standard analog transducers such as 4 - 20 mA current transducers.

Related Topics

- Option modules

Analog output behavior

Your meter’s analog output, once configured, outputs voltage or current signals. If your meter’s analog output source becomes unavailable (N/A) the analog output level should go to zero (0 V / 0 mA) under most conditions.

When your meter is powered off or configured to send voltage, the meter registers as a high impedance.

The electrical signal on the analog output is DC; make sure proper polarity is observed when wiring external devices to the analog output ports.

Analog output zero scale and full scale values

Configure your analog output’s zero and full scale values.

In most cases, your meter’s analog output range matches the range of the analog sensors that your meter’s outputs are connected to. In that case, your meter’s analog output zero scale and full scale values are the maximum and minimum values of the source driving your meter’s analog output. These values are used to normalize the source value to a value between 0 and 1 which is applied to the operating range of the analog output port to determine the analog output current or voltage. For example:

Source value	Analog output values	Meter’s analog output	Analog sensor
0 to 120 kW range 100 kW	Full scale = 120 (kW) Zero scale = 0 (kW) Normalized: 0.83	4 - 20 mA range Output: 17.28 mA	4 - 20 mA range

If your meter’s analog output range does not match the range of the connected analog sensor, you must calculate the full scale and zero scale values by analyzing the system.

See the *ION Reference*, available from www.schneider-electric.com for detailed information about the Analog Output module and full scale and zero scale calculations.

Configuring option module analog outputs using ION Setup

You can configure option module analog outputs using ION Setup.

Analog outputs are available on the optional I/O modules you can connect to the base of your meter.

Calculate your zero scale and full scale values based on the measured value and the analog output range of your meter.

Make sure that the analog output port that you want to use is properly connected to an analog receiver.

1. Start ION Setup.
2. Open the Setup Assistant for your meter.
3. Navigate to **Expansion Modules > Option I/O Modules** and select the module tab that corresponds to the option module with the analog output you want to configure.
4. Select the analog output channel and click **Edit**. Enter the meter password if prompted. The setup screen for that analog output is displayed.
5. Configure the analog output by selecting the parameter and clicking **Edit**.

Parameter	Value/Range	Description
Zero scale	0 to ±10 ⁹	The minimum source value that matches the minimum analog output signal.
Full scale	0 to ±10 ⁹	The maximum source value that matches the maximum analog output signal.
Port	–	The physical analog output port connection.
Mode	Voltage, current	Determines whether the analog output is monitoring voltage or current.

Related Topics

- Option I/O modules configuration

Digital inputs

Digital input applications

Digital inputs are typically used for monitoring the status of switches or contacts, such as status contacts on circuit breakers.

They can also be used for pulse counting or input metering applications, such as WAGES (water, air, gas, electricity, steam) monitoring, or conditional energy applications, or IIRIG-B time synchronization.

Typical applications for the digital input are switch or relay status monitoring, KYZ transitions, AC detection.

Pulse mode

If you set Input Mode to PULSE, a pulse is generated at the Trigger output when the State output changes from OFF-to-ON. No pulse is generated when State changes from ON-to-OFF.

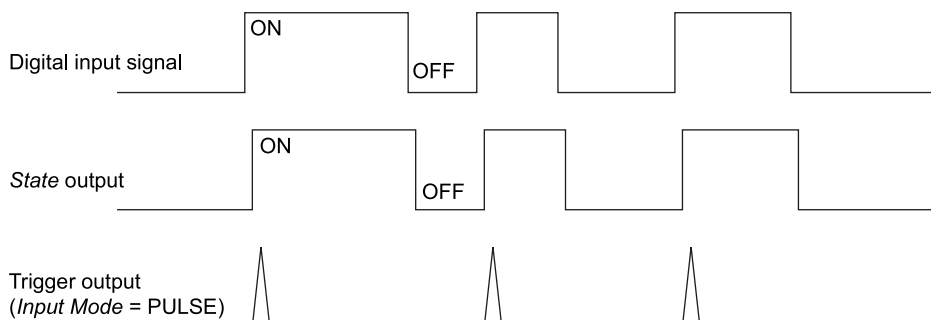

KYZ mode

If you set Input Mode to KYZ, a pulse is generated at the Trigger output for each change of state transition, i.e. from OFF-to-ON and from ON-to-OFF transitions.

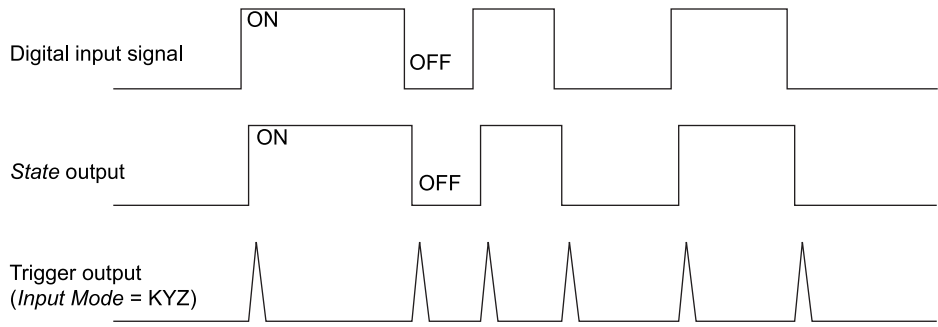

A/C mode

If you set Input Mode to A/C, the digital input port is configured to detect the presence of an A/C waveform. The next illustration shows how a digital input can be used to monitor the operation of a fan.

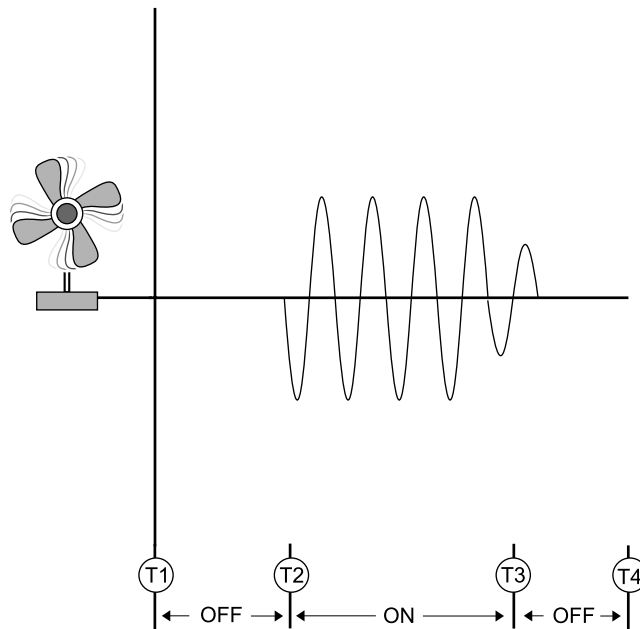

IRIG-B time synchronization

You can use a digital input to synchronize the meter time to an IRIG-B time source.

You can connect an IRIG-B time source to one of meter's digital inputs for IRIG-B time synchronization; for improved accuracy use the digital inputs on the meter base. For IRIG-B time synchronization, you must configure both the meter's digital input and the meter's clock.

Related Topics

- Configuring time information using ION Setup

Configuring onboard digital inputs using ION Setup

You can use ION Setup to configure your meter's digital inputs.

1. Start ION Setup.
2. Open the Setup Assistant for your meter.

3. Navigate to **Onboard I/O > Digital Inputs**. The tabs correspond to each digital input. Click on the tab for the digital input you want to edit.
4. Configure the digital input by selecting the parameter and clicking **Edit**.
5. Once the parameter has been configured, click **OK** to save the setting to the meter.

Parameter	Value/range	Description
Input Mode	Pulse, KYZ, A/C, IRIG-B ¹	Specifies how the meter processes the signal: <ul style="list-style-type: none"> • Pulse: the meter counts an entire pulse (from off-on to on-off) as one input. • KYZ: the meter counts a transition (from off-on or from on-off) as one input. • A/C: the meter detects analog signals where the ON condition is based on the presence of an AC signal • IRIG-B¹: the meter detects an IRIG-B time synchronization signal.
Polarity	Inverting/Non-Inverting	Specifies if the signal from the digital port is inverted or not inverted.
Debounce	0.000 - 1.000	Specifies how long (in seconds) the signal must remain in a state to be considered a valid state change.
Assigned Port	Defined by your meter's hardware	Your meter's physical digital input port.
EventLog Mode	Log Off/Log On	Specifies if events generate log entries.
State	OFF/ON	Indicates the status of the digital input.

¹ IRIG-B can only be connected to one of the onboard digital inputs, not an option module. You must also configure your meter's clock to use IRIG-B time synchronization.

Configuring option module digital inputs using ION Setup

You can configure option module digital inputs using ION Setup.

Digital inputs are available on your meter. You can add more digital inputs using optional I/O modules.

1. Start ION Setup.
2. Open the Setup Assistant for your meter.
3. Navigate to **Expansion Modules > Option I/O Modules** and select the module tab that corresponds to the option module with the digital input you want to configure.
4. Select the digital input channel and click **Edit**.
The setup screen for that digital input is displayed.
5. Configure the digital input by selecting the parameter and clicking **Edit**.

6. Once the parameter has been configured, click **OK** to save the setting to the meter.

Parameter	Value/Range	Description
Input Mode	Pulse, KYZ, A/C, IRIG-B ¹	Specifies how the meter processes the signal: <ul style="list-style-type: none"> • Pulse: the meter counts an entire pulse (from off-on to on-off) as one input. • KYZ: the meter counts a transition (from off-on or from on-off) as one input. • A/C: the meter detects analog signals where the ON condition is based on the presence of an AC signal. • IRIG-B¹: the meter detects an IRIG-B time synchronization signal.
EvLog Mode	Log Off/Log On	Specifies if events generate log entries.
Event Priority	0 - 255	Specifies the priority of an event.
Polarity	Inverting/Non-Inverting	Specifies if the signal from the digital port is inverted or not inverted.
Debounce	0.000 - 1.000	Specifies how long (in seconds) the signal must remain in a state to be considered a valid state change.
Port	Defined by your meter's hardware	Your meter's physical digital input port.
Enable	Enabled/Disabled	Specifies whether the module is enabled or disabled.
Alarm Trigger Mode	Alarm off OFF/Alarm on ON	Specifies the behavior of the digital input alarm.

¹ IRIG-B can only be connected to one of the digital inputs located on the meter base, not an option module.

Related Topics

- Option I/O modules configuration

WAGES monitoring

WAGES monitoring allows you to record and analyze all energy sources and utilities usage.

Your system may use several different types of energy. For example, you may consume steam or compressed air for industrial processes, electricity for lights and computers, water for cooling and natural gas for heating. WAGES monitoring collects the usage information from all these different energy sources to enable a more complete energy analysis.

WAGES information can help you:

- Identify losses or inefficiencies.
- Modify demand to reduce costs.
- Optimize energy source usage.

WAGES example

This example shows WAGES monitoring for a water flow meter.

You can connect your meter's digital input to a transducer that sends a pulse for every 15 kiloliters (4000 US Gal) of water. After configuring an input metering channel and assigning it to the digital input, the meter is able to detect and record the incoming pulses. An energy management system can then use the information from the meter to perform WAGES analysis.

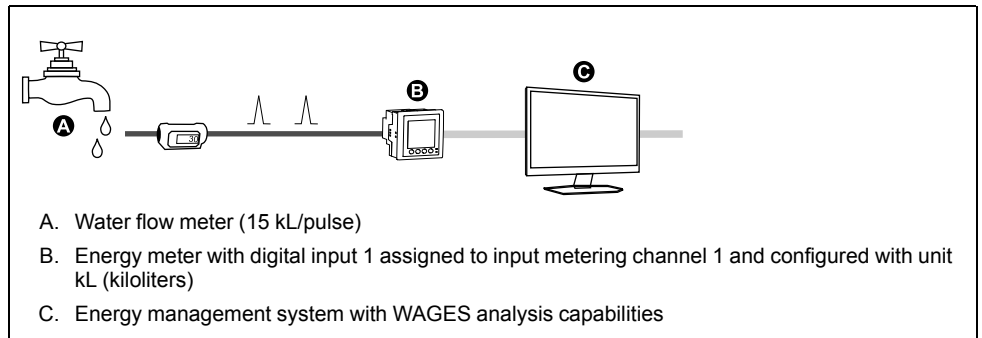

Input metering

Your meter's digital inputs can be used to count pulses from transducers and convert the pulses to energy measurements.

Your meter's input metering channels count pulses received from the digital inputs assigned to that channel. The incoming pulses are used in calculating and measuring consumption data (e.g., BTU, kWh, L, kg). Each channel must have the following values configured to match the pulse data:

- Pulse Weight: the pulses per unit value.
- Unit Code: the unit of measure associated with the monitored value.
- Demand Code: for time-based values (such as kWh), this provides the associated demand units (kW) for demand calculations; for other values (such as kg), this can be configured to provide rate information (kg/h or kg/s).
- Mode: whether a pulse is based on a complete pulse or a transition.

For example, if each complete pulse represents 125 Wh, you can configure for Wh pulsing as follows:

- Pulse Weight = pulses/Wh = $1/125 = 0.008$
- Unit Code = Wh
- Demand Code = kW (this is automatically set)
- Mode = pulse

If you want to configure for kWh pulsing, you must adjust the pulse weight calculation and unit code as follows:

- Pulse Weight = pulses/kWh = $1/0.125 = 8$
- Unit Code = kWh

Related Topics

- Meter resets

Configuring standard input metering using ION Setup

You can configure input metering with standard units and rates using ION Setup

When configuring your meter, the configuration interface may show all of the possible ports, regardless of what is physically available on your meter.

NOTE: Your device's digital input must be connected to the input metering pulse source. Review the digital inputs assigned to applications to help you understand your existing configuration.

NOTE: To disable an input metering channel and remove any port associations, set Assigned Input to No connection.

1. Start ION Setup.
2. Open the Setup Assistant for your meter.
3. Navigate to **Energy Applications > Digital Input Based**.

4. Select the input metering channel you want to configure and click **Edit**. The **Input Metering Channel Setup** screen is displayed.
5. Select **Enabled** to enable the input metering feature.
6. Click **Select** to define which digital input is the pulse source for the input metering channel.
7. Configure the remaining parameters as required.
8. Click **OK** to save your configuration.
9. Configure your meter to log the input metering data if required.

Parameter	Description
Pulse Weight	Enter the value per pulse.
Units	Select the measurement units associated with the pulse.
Demand Period	Enter the frequency in minutes that input metering data is calculated in your energy management system.
Rate	Select the rate associated with the defined Units.
Source ID	Enter a data identifier. This value is added to the input metering channel's output register labels to uniquely identify the data within your energy management system. NOTE: You must select a Unit for this field to appear.

Configuring custom input metering using ION Setup

You can configure input metering with custom units and rates using ION Setup.

When configuring your meter, the configuration interface may show all of the possible ports, regardless of what is physically available on your meter.

NOTE: Your device's digital input must be connected to the input metering pulse source. Review the digital inputs assigned to applications to help you understand your existing configuration.

NOTE: To disable an input metering channel and remove any port associations, set Assigned Input to No connection.

1. Start ION Setup.
2. Open the Setup Assistant for your meter.
3. Navigate to **Energy Applications > Digital Input Based**.
4. Select the input metering channel you want to configure and click **Edit**. The **Input Metering Channel Setup** screen is displayed.
5. Select **Enabled** to enable the input metering feature.
6. Click **Select** to define which digital input is the pulse source for the input metering channel.
7. Clear the **Standard quantity** checkbox. The screen changes to display custom input metering parameters.
8. Configure the remaining parameters as required.
9. Click **OK** to save your configuration.

10. Configure your meter to log the input metering data if required.

Parameter	Description
Pulse Weight	Enter the value per pulse.
Units	Select the measurement units associated with the pulse. NOTE: Include source identification information by entering "@" followed by the source identifier.
Demand Period	Enter the frequency in minutes that input metering data is calculated in your energy management system.
Rate	Select the rate associated with the defined Units.
Scaling	Select the scaling value based on the relationship between Units and Rate.
Time Base	Select the value and units to match the Rate.

Digital outputs

Digital output applications

Digital outputs are typically used in switching applications, for example, to provide on/off control signals for switching capacitor banks, generators, and other external devices and equipment.

The digital output can also be used in demand synchronization applications, where the meter provides pulse signals to the input of another meter to control its demand period. The digital output can also be used in energy pulsing applications, where a receiving device determines energy usage by counting the kWh pulses coming from the meter's digital output port.

The digital output ports on the meter are internally designed using solid-state devices with an open-collector configuration. These ports must be connected to the specified power supply to function. The port terminals does not behave like a typical NO electromechanical relay. Refer to the *digital output application example* below for more information.

Related Topics

- Option modules

Configuring onboard digital outputs using ION Setup

You can use ION Setup to configure your meter's digital outputs.

1. Start ION Setup.
2. Open the Setup Assistant for your meter.
3. Navigate to **Onboard I/O > Digital Outputs** and select a digital output tab.

- Configure the digital output by selecting the parameter and clicking **Edit**. Enter the meter password if prompted.

Parameter	Value/range	Description
Source	Digital/Boolean	Link this input to the value that drives the state of the digital output. If Source is not linked, the digital output state is driven by the Force ON, Force OFF values.
Force ON	Pulse	Link this input to a pulse that forces the digital output on for the PulseWidth duration, regardless of the Source input.
Force OFF ¹	Pulse	Link this input to a pulse that forces the digital output off.
Normal ¹	Pulse	Pulsing this input will switch the driver of the digital output from Force ON to Source.
Polarity	Inverting/non-inverting	Specifies if the signal to the digital port is inverted or not inverted.
PulseWidth	0 - 2,000,000	Specifies the duration of the pulse, in seconds. Setting this parameter to 0 sets the digital output continuously on.
Assigned Port	—	The physical digital output port connection. Only available ports are shown.
State	Open/Closed/Not Available	Indicates the status of the digital output.

¹ These parameters are only valid when pulse width is set to 0.

Configuring option module digital outputs using ION Setup

You can configure option module digital outputs using ION Setup.

- Start ION Setup.
- Open the Setup Assistant for your meter.
- Navigate to **Expansion Module > Option I/O Modules** and select the module tab that corresponds to the option module with the digital output you want to configure.
- Select the digital output channel and click **Edit**. The setup screen for that digital output is displayed.

5. Configure the digital output by selecting the parameter and clicking **Edit**.

Parameter	Value/Range	Description
Source	Digital/Boolean	Link this input to the value that drives the state of the digital output. If Source is not linked, the digital output state is driven by the Force ON, Force OFF values.
Force ON	Pulse	Link this input to a pulse that forces the digital output on for the PulseWidth duration, regardless of the Source input.
Force OFF ¹	Pulse	Link this input to a pulse that forces the digital output off.
Normal ¹	Pulse	Pulsing this input will switch the driver of the digital output from Force ON to Source.
EventLog Mode	Log Off/Log On	Specifies if events generate log entries.
Polarity	Inverting/non-inverting	Specifies if the signal to the digital port is inverted or not inverted.
PulseWidth	0 - 2,000,000	Specifies the duration of the pulse, in seconds. Setting this parameter to 0 sets the digital output continuously on.
Port	–	The physical digital output port connection. Only available ports are shown.

¹ These parameters are only valid when pulse width is set to 0.

Related Topics

- Option I/O modules configuration

Energy pulsing

You can configure the meter’s energy pulsing LEDs or onboard digital outputs for energy pulsing applications.

When an LED or output is set to energy pulsing, the meter sends a readable pulse or signal based on the measured energy source value. This pulse can be used for accuracy verification or as an input to another energy monitoring system.

Default energy pulsing LED sources

Your meter’s energy pulsing LEDs have default energy source values configured for accuracy verification testing.

For LED locations, see your meter’s installation guide.

LED	Default energy pulsing source
kVARh pulse LED kVARh pulse infrared LED	kVAR del+rec
kWh pulse LED kWh pulse infrared LED	kW del+rec

NOTE: The energy pulsing LEDs are configured in pairs. For example, changing the energy source value will change it for both the regular and infrared kVARh LEDs.

NOTE: To modify your default energy source value, go into the advanced mode of ION Setup and modify the associated Calibration Pulser module. This is an advanced procedure that should only be performed if you have advanced knowledge of ION and the power system your meter is connected to.

See the *ION Reference*, available from www.schneider-electric.com, for more information.

Related Topics

- Alarm and status LED indicators

Configuring LED energy pulsing using ION Setup

You can configure your meter's energy pulsing LEDs for energy pulsing using ION Setup.

1. Start ION Setup.
2. Open the Setup Assistant for your device.
3. Select **LED pulsing**.
4. Select the tab that corresponds to the energy pulsing LED you want to configure.
5. Configure the following basic parameters for your meter's energy pulsing LEDs.

Energy pulsing LED parameters available through ION Setup

Parameter	Description
Source	Link this input to the value that you want to pulse on the LED.
Enable	Configuring this setting should only be performed by users with advanced knowledge of ION, the device template and the power system the device is connected to.
Int Mode	Specifies the integration mode for the LED (forward, reverse, absolute or net).
Kt	The amount of source energy required to make the LED pulse.
Pulse Width	The minimum time in seconds between LED pulse transitions.
Pulser Mode	Select when the energy pulsing LEDs will pulse: <ul style="list-style-type: none"> • Always: the energy pulsing LEDs are always pulsing based on their energy source value. • Test Only: the energy pulsing LEDs will only pulse when the meter is in test mode.
Pulse ovrd	Pulsing normally indicates that the energy pulsing LED should be operating normally. Pulsing suspended indicates that the energy pulsing LED is not able to pulse quickly enough. Modify the Kt value to decrease the number of energy pulses or decrease the pulse width, if supported by the device collecting pulses.

NOTE: To perform specialized configuration go into the advanced mode of ION Setup and modify, disable or add a new Calibration Pulser module. These are advanced procedures that should only be performed if you have advanced knowledge of ION and the power system your meter is connected to.

See the *ION Reference*, available from www.schneider-electric.com, for more information.

Configuring digital output energy pulsing using ION Setup

You can configure your meter's onboard digital outputs for energy pulsing using ION Setup

Ensure that the digital output port is available for energy pulsing and not associated with another function.

When configuring your meter, the configuration interface may show all of the possible ports, regardless of what is physically available on your meter.

NOTE: For applications where accuracy is important, use the digital output located on the meter base.

1. Start ION Setup.
2. Open the Setup Assistant for your device.
3. Select **Energy pulsing**.
4. Select an energy pulsing source tab (such as Wh Del) to configure energy pulsing using your meter’s digital output.

Digital output energy pulsing parameters available through ION Setup

Parameter	Description
Kt	The amount of energy source required to trigger the digital output. For example, in the Wh Del tab, the Kt value would be amount of real energy delivered (Wh Del) per pulse.
Pulse Width	The minimum time in seconds between pulse transitions.
OutputMode	Select the desired output mode: <ul style="list-style-type: none"> • Pulse: the digital output sends a complete pulse when triggered. • KYZ: the digital output makes a transition (off to on, or on to off) when triggered.
Port	Select an output port from the list. Only available output ports are shown (ports that are not associated with another function).
(energy source) ovrlid	Pulsing normally indicates that the output port should be operating normally. Pulsing suspended indicates that the output port is not able to pulse quickly enough. Modify the Kt value to decrease the number of energy pulses.

NOTE: To perform specialized configuration go into the advanced mode of ION Setup and modify or add a new Calibration Pulser module. This is an advanced procedure that should only be performed if you have advanced knowledge of ION and the power system your meter is connected to.

See the *ION Reference*, available from www.schneider-electric.com, for more information.

Calculate your maximum kWh/pulse (pulse weight) value

To calculate the kWh/pulse (pulse weight) value, divide the highest kW value you can expect by the required pulse rate.

Make sure the required pulse rate does not exceed the maximum pulse rate for the digital output.

NOTE: To convert from kWh/pulse to pulse/kWh you must invert (take the reciprocal) of the value. For example, 1.8 kWh/pulse becomes 0.556 pulse/kWh.

Example pulse weight calculation

For a maximum load of 1600 kW and a pulse rate of 2 pulses per second, calculate the kWh/pulse value as follows:

1. Convert 1600 kW load into kWh/second:

$$(1600 \text{ kW}) \cdot (1 \text{ hr}) = 1600 \text{ kWh}$$

$$(1600 \text{ kWh}) / (3600 \text{ sec}) = (X \text{ kWh}) / (1 \text{ sec})$$

$$X = 0.444 \text{ kWh/sec}$$
2. Calculate the kWh required per pulse:

$$(0.444 \text{ kWh/sec}) / (2 \text{ pulses per second}) = 0.222 \text{ kWh/pulse}$$
3. If using KYZ Output Mode, adjust for the KY giving one pulse per 2 transitions if necessary.

$$(0.222 \text{ kWh/pulse}) / (2) = 0.111 \text{ kWh/pulse}$$

See the *ION Reference*, available from www.schneider-electric.com for detailed information about the Calibration Pulser module.

Webpages

Webpage interface

Your meter comes with default webpages that contain typical elements.

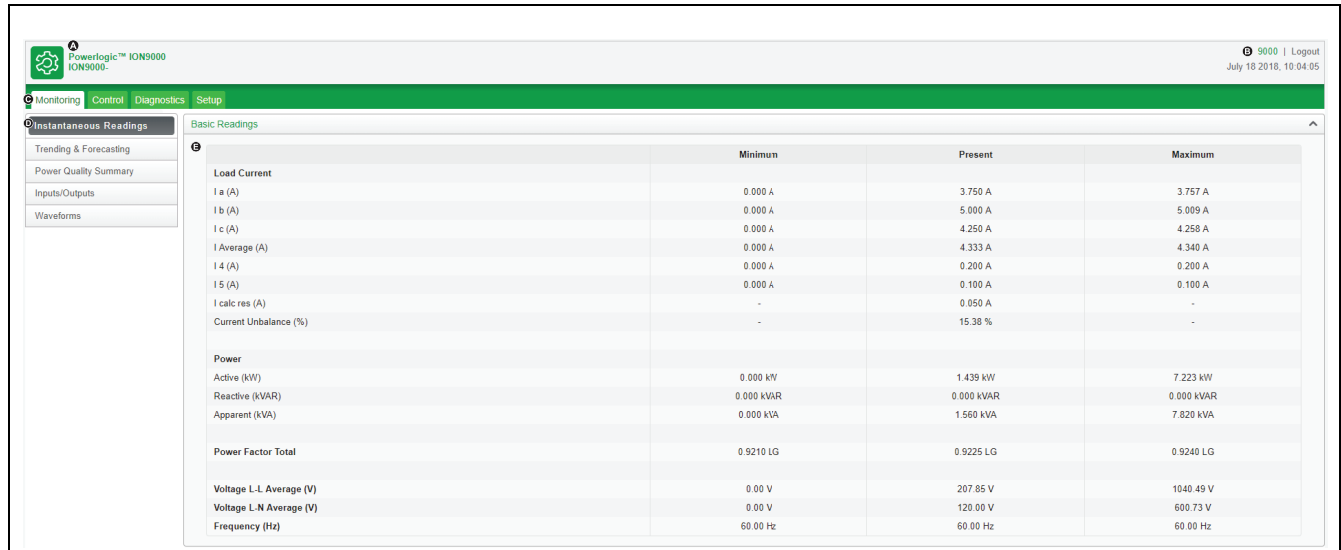

	Minimum	Present	Maximum
Load Current			
I a (A)	0.000 A	3.750 A	3.757 A
I b (A)	0.000 A	5.000 A	5.009 A
I c (A)	0.000 A	4.250 A	4.258 A
I Average (A)	0.000 A	4.333 A	4.340 A
I 4 (A)	0.000 A	0.200 A	0.200 A
I 5 (A)	0.000 A	0.100 A	0.100 A
I calc res (A)	-	0.050 A	-
Current Unbalance (%)	-	15.38 %	-
Power			
Active (kW)	0.000 kW	1.439 kW	7.223 kW
Reactive (kVAR)	0.000 kVAR	0.000 kVAR	0.000 kVAR
Apparent (kVA)	0.000 kVA	1.560 kVA	7.820 kVA
Power Factor Total	0.9210 LG	0.9225 LG	0.9240 LG
Voltage			
Voltage L-L Average (V)	0.00 V	207.85 V	1040.49 V
Voltage L-N Average (V)	0.00 V	120.00 V	600.73 V
Frequency (Hz)	60.00 Hz	60.00 Hz	60.00 Hz

A	Meter type and model, device name
B	Username
C	Main menu
D	Webpage menu
E	Webpage content

NOTE: This graphic is representative only, and your meter’s webpages may appear differently than shown.

Default meter webpages

Default webpages are available on your meter.

Monitoring

Webpage menu	Webpage content
Instantaneous Readings	<ul style="list-style-type: none"> Basic readings Energy readings Demand readings Voltage readings Power Quality
Trending & Forecasting	Select the target and interval for trending and forecasting and view the results.
Power Quality Summary	<ul style="list-style-type: none"> Harmonics Chart ITI (CBEMA)-SEMI NEMA Motor Derating Curve EN50160 IEEE 519 Harmonics

Webpage menu	Webpage content
Inputs/Outputs	<ul style="list-style-type: none"> Digital inputs Digital outputs Analog inputs Analog outputs
Waveforms	View waveforms from your meter, using the meter's COMTRADE files

Control

Webpage menu	Webpage content
Resets	Perform resets, and view when previous resets were performed.

Diagnostics

Webpage menu	Webpage content
Statistics	<ul style="list-style-type: none"> Communications Ethernet Serial port Meter - Basic Meter - Advanced
Phasor diagram	View the phasor diagram and numeric values.

Setup

Webpage menu	Webpage content
Ethernet	<ul style="list-style-type: none"> Basic Settings Advanced settings
Serial Port	<ul style="list-style-type: none"> Basic Settings Advanced settings
SNMP Parameters	Configure your meter's SNMP parameters.
NTP	Configure your meter's NTP parameters.
SMTP	Configure your meter's SMTP parameters.
Date & Time	Configure your meter's time and time synchronization.
Preferences	Enter your meter's nameplate information.
Metering	<ul style="list-style-type: none"> Basic Settings Advanced settings
HTTPS	Certificate Management.

Maintenance

Webpage menu	Webpage content
—	<p>Custom. No default content.</p> <p>By default the Maintenance menu is empty, and the menu is not displayed until information is added to it.</p>

Accessing webpages for data viewing and meter configuration

You can access the meter's webpages through the meter's Ethernet connection using a web browser.

You must have cookies enabled in order to access your meter's webpages.

You may need to configure your meter's security settings in order to view webpages and configure your meter using webpages.

On a hardware-locked meter, you cannot add, delete or modify any webpage files.

If you are connected to your device over Ethernet, changing Ethernet configuration parameters without another method of configuration enabled may cause loss of communications with your device and render it inaccessible.

NOTICE

LOSS OF ACCESS

Ensure you maintain sufficient access to communicate to and configure your device.

Failure to follow these instructions can result in loss of access to the device.

1. Open a web browser and enter your meter's IP address in the address box. The webpage login prompt is displayed.

If the browser cannot connect to the webserver, check the web protocol setting.

2. Enter a valid username and password.

NOTE: The username and password are defined by your meter's security configuration; if standard security is enabled, the password is the same as the display password with a default username of 9000. The default display password is 0 (zero). To help increase the security of your meter's configuration and data, configure your meter's username and passwords to be different from the default values.

3. Select your desired **Language** from the dropdown list, and click **Log In**.

Your meter's webpages are displayed. The default page is the **Monitoring** webpage, showing real-time data.

4. Select the main menu tab that corresponds to the category of information you want to view, and select the webpage menu from the list on the left.

The webpage content is displayed.

5. Click the webpage content headings to expand and view the meter's data.

6. Select **Setup** to view and edit your meter's configuration.

Related Topics

- Factory default settings

Viewing files using your meter's webpages

You can load files of a variety of standard formats, such as *.pdf, *.jpg and *.png into the webpage folders on your meter's internal FTP site where they can be viewed using your meter's webpages.

Videos in *.mp4 format can be played in most browsers. The filenames must be compatible with your meter's FTP filename requirements.

NOTE: Image files are shown at full-size (100%). Scale images to the desired size before loading them onto your meter's internal FTP site.

1. Access your meter's internal FTP site.
2. Open the web folder. Copy your file into the subfolder that corresponds to the webpage main menu tab you want to access your file from.
3. Connect to your meter's webpages. Select the main menu item that corresponds to the folder where you stored your file in step 2. Your file is listed in the webpage menu.

4. Select your file from the webpage menu to view.

Example

To view a schematic diagram (online.pdf) of your power system from the Monitoring menu of your meter's webpages:

1. Access your meter's internal FTP site.
2. Copy online.pdf into **web > monitoring**.
3. Access your meter's internal webpages and select the **Monitoring** menu.
4. In the webpage menu click online.pdf to view your power system schematic.

Related Topics

- FTP
- FTP filename requirements

Creating custom webpages for your meter

You can create custom webpages to view data or access configuration parameters from your meter.

Download the your meter's Modbus registers map from www.schneider-electric.com.

1. Connect to your meter's internal FTP site.
2. Go to **web > examples**. Select `sample readings.html` to create a data value webpage, or select `sample configuration.html` to create a configuration parameters webpage.
3. Save a copy of the sample file. This filename is the webpage name.
4. Open your webpage in an HTML or webpage editor program.
5. Modify the webpage to reference the desired meter data or parameters from the Modbus registers map, and update the other fields where required.
6. Save your custom webpage.
The meter will display translated content if it exists in the meter's memory. If translated content is not available, English is displayed.
7. Connect to your meter's internal FTP site.
 - If you have created a data viewing webpage, copy your custom webpage to **web > monitoring**.
 - If you have created a configuration webpage, copy your custom webpage to **web > setup**.
8. Login to your meter's webpages.

Your custom webpage is available from the webpage menu under the monitoring (data viewing) or setup (configuration) tab.

Watch the video on how to create custom webpages: *How to Create Custom Webpages for Your Meter*

Related Topics

- FTP

Sample data viewing webpage

You can create custom data viewing webpages using the sample webpage stored on your meter.

The sample webpages are stored in the documents folder on your meter’s internal FTP site.

Your meter’s Modbus register map is available from www.schneider-electric.com.

If required, your meter’s ION handles document is packaged with the meter firmware file which is available for download from www.schneider-electric.com.

The data viewing webpage must be stored on your meter’s internal FTP site in the folder for Monitoring. The custom webpage is viewed by selecting the Monitoring main menu tab on your meter’s webpage.

Configuring the HTML code other than where described is an advanced procedure and should only be performed by those with an advanced understanding of webpages and how your meter processes them.

Sample webpage data viewing result

NOTE: This graphic is representative only, and your meter’s webpages may appear different than shown.

The screenshot shows a web interface with a green header and a sidebar menu. The main content area displays 'Basic Readings' with a table. Callouts A through G point to various elements: A (HTML filename), B (Content pane title), C (Row heading), D (Units), E (Column heading), F (Named register instantaneous value), and G (Second content pane A title).

	Minimum	Present	Maximum
I a (A)	0.00	3.76	3.76
I b (A)	0.00	5.01	5.01

A	HTML filename
B	Content pane title
C	Row heading
D	Units
E	Column heading
F	Named register instantaneous value
G	Second content pane A title

Sample HTML code for data viewing webpage content

Content and formatting of a data viewing webpage is controlled by its HTML code.

Sample data viewing webpage content

Line #	Sample HTML
1	SampleMonitorPane.html
2	<div class="content-fit">
3	<div class="accordion">
4	<h3 target="sample-readings">\${%localizedString(Basic Readings) #}\$</h3>
5	<div id="sample-readings">
6	<table class="datatable">

Line #	Sample HTML
7	<tr>
8	<th> </th>
9	<th>\${%localizedString (Minimum) #}</th>
10	<th>\${%localizedString (Present) #}</th>
11	<th>\${%localizedString (Maximum) #}</th>
12	</tr>
13	<tr class="minor">
14	<td>\${%localizedString (I a) #} </td>
15	<td regname="I a mn"></td>
16	<td regname="I a"></td>
17	<td regname="I a mx"></td>
18	</tr>
19	<tr class="minor">
20	<td>\${%localizedString (I b) #} </td>
21	<td regname="I b mn"></td>
22	<td regname="I b"></td>
23	<td regname="I b mx"></td>
24	</tr>
25	</table>
26	</div>
27	<h3 target="sample-energy">\${%localizedString (Energy Readings) #}</h3>
28	<div id="sample-energy">
29	<table class="datatable">
30	<tr>
31	<th> </th>
32	<th>\${%localizedString (Present) #}</th>
33	</tr>
34	<tr>
35	<td>\${%localizedString (Active Energy) #} </td>
36	<td regname="kWh del-rec"></td>
37	</tr>
38	<tr>
39	<td>\${%localizedString (Reactive Energy) #} </td>
40	<td regname="kVARh del-rec"></td>
41	</tr>
42	</table>
43	</div>
44	</div>
45	
46	
47	<script type="text/javascript">
48	
49	instantaneousReadings.initInstantaneousReadings ('sample-readings');
50	

Line #	Sample HTML
51	</script>
52	</div>

Sample webpage data viewing content description

Line #	Description
1	SampleMonitorPane.html The HTML filename, including the HTML extension (.html). This filename must comply with FTP filename conventions (no spaces or special characters). The filename (without the HTML extension) is the name shown on the webpage menu.
4	<h3 target="sample-readings"> This creates the first webpage content pane. "sample-readings" is the name of the webpage content. This name must be unique. \$%localizedString(Basic Readings) #</h3> Basic Readings is the title of the webpage content pane. This title is translated if possible.
5	<div id="sample-readings"> This must match the name of the webpage content in line 4.
9	<th>\$%localizedString(Minimum) #</th> Minimum is the heading for the first column. This heading is translated if possible.
10	<th>\$%localizedString(Present) #</th> Present is the heading for the second column. This heading is translated if possible.
11	<th>\$%localizedString(Maximum) #</th> Maximum is the heading for the last column. This heading is translated if possible.
14	<td>\$%localizedString(I a) # I a is the row heading. This heading is translated if possible. </td> This displays the units that the meter has defined for the named register I a.
15	<td regname="I a mn"></td> This displays the instantaneous value of the named register I a mn.
16	<td regname="I a"></td> This displays the instantaneous value of the named register I a.
17	<td regname="I a mx"></td> This displays the instantaneous value of the named register I a mx.
20	<td>\$%localizedString(I b) # I b is the second row heading. This heading is translated if possible. </td> This displays the units that the meter has defined for the named register I b.
21	<td regname="I b mn"></td> This displays the instantaneous value of the named register I b mn.
22	<td regname="I b"></td> This displays the instantaneous value of the named register I b.
23	<td regname="I b mx"></td> This displays the instantaneous value of the named register I b mx.
27	<h3 target="sample-energy"> This creates the second webpage content pane. Sample-energy is the name of the webpage content. This name must be unique. \$%localizedString(Energy Readings) #</h3> Energy Readings is the title of the webpage content pane. This title is translated if possible.
28	<div id="sample-energy"> This must match the name of the webpage content in line 27.
32	<th>\$%localizedString(Present) #</th> Present is the heading for the last column. This heading is translated if possible.
35	<td>\$%localizedString(Active Energy) # Active Energy is the row heading. This heading is translated if possible. </td> This displays the units that the meter has defined for the named register kWh del-rec.
36	<td regname="kWh del-rec"></td> This displays the instantaneous value of the named register kWh del-rec. ¹
39	<td>\$%localizedString(Reactive Energy) # Reactive Energy is the row heading. This heading is translated if possible. </td>

Line #	Description
	This displays the units that the meter has defined for the named register kVARh del-rec.
40	<td regname="kVARh del-rec"></td> This displays the instantaneous value of the named register kVARh del-rec. ¹
49	instantaneousReadings.initInstantaneousReadings('sample-readings'); Sample-readings is the unique name of the first webpage content name. This HTML code updates all of the webpage's values.

¹Named registers are listed in the Modbus registers map. If the desired value is not listed, you can reference the value by its ION handle, using the following format: <td regname="_0x####"></td>, where #### is the hexadecimal value of the ION handle.

Sample setup webpage

You can create custom setup webpages using the sample webpage stored on your meter.

Sample webpages are stored in the documents folder on your meter's internal FTP site.

Your meter's Modbus register map is available from Schneider Electric.

If required, your meter's ION handles document is packaged with the meter firmware file which is available for download from www.schneider-electric.com.

Custom setup webpages must be stored on your meter's internal FTP site in the folder for Setup. The custom webpage is viewed by selecting the Setup main menu tab on your meter's webpage.

Configuring the HTML code other than where described is an advanced procedure and should only be performed by those with an advanced understanding of webpages and how your meter processes them.

Sample webpage setup result

NOTE: This graphic is representative only, and your meter's webpages may appear different than shown.

A	HTML filename
B	Content pane title
C	Sub-heading
D	Row heading
E	Named register value
F	Second content pane title

Sample HTML code for setup webpage content

Content and formatting of a setup webpage is controlled by its HTML code.

Sample setup webpage content

Line #	Sample HTML
1	SampleSetupPane.html
2	
3	<div class="content-fit">
4	<form id="formSampleSettings">
5	
6	<div class="accordion">
7	<h3 target="sample-basic">\${localizedString(Basic Settings)} #</h3>
8	<div id="sample-basic">
9	<table class="formtable">
10	<tr>
11	<th> </th>
12	<th> </th>
13	</tr>
14	<tr>
15	<td>\${localizedString(Ethernet)} #</td>
16	<td> </td>
17	</tr>
18	<tr class="minor">
19	<td>\${localizedString(MAC Address)} #</td>
20	<td regname="MAC Address"></td>
21	</tr>
22	<tr class="minor">
23	<td>\${localizedString(Ethernet Device Name)} #</td>
24	<td><input name="Ethernet Device Name" type="text" /></td>
25	</tr>
26	<tr class="minor">
27	<td>\${localizedString(IP Address)} #</td>
28	<td><input name="IP Address" type="text" /></td>
29	</tr>
30	</table>
31	
32	</div>
33	
34	<h3 target="sample-advanced">\${localizedString(Advanced Settings)} #</h3>
35	<div id="sample-advanced">
36	<table class="formtable" id="frameFormatDropdownContainer">
37	<tr>
38	<th> </th>
39	<th> </th>
40	</tr>
41	<tr>
42	<td>\${localizedString(TCP Keep Alive Minutes)} #</td>
43	<td><input type="text" name="TCP Keep Alive Minutes" class="small" /> </td>

Line #	Sample HTML
44	</tr>
45	<tr>
46	<td>\${%localizedString (Enable Web Server) #}\$</td>
47	<td><select name="Enable Web Server"></select> </td>
48	</tr>
49	</table>
50	
51	</div>
52	</div>
53	
54	<input type="submit" class="apply" value='\${%localizedString (Apply) #}\$' />
55	
56	</form>
57	
58	
59	<script type="text/javascript">
60	
61	SetupPane.init('formSampleSettings');
62	formChangeDetection.initFormChangeDetection('#formSampleSettings', '#dialogFormChanges');
63	
64	</script>
65	</div>

Sample setup webpage content description

Line #	Description
1	SampleSetupPane.html The HTML filename, including the HTML extension (.html). This filename must comply with FTP filename conventions (no spaces or special characters). The filename (without the HTML extension) is the name shown on the webpage menu.
4	<form id="formSampleSettings"> "formSampleSettings" is the name of the webpage content. This name must be unique
7	<h3 target="sample-basic"> This creates the first webpage content pane. "sample-basic" is the name of the webpage content. This name must be unique. \${%localizedString (Basic Settings) #}\$</h3> Basic Settings is the title of the webpage content pane. This title is translated if possible.
8	<div id="sample-basic"> This must match the name of the webpage content in line 7.
15	<td>\${%localizedString (Ethernet) #}\$</td> Ethernet is the subheading. This heading is translated if possible.
19	<td>\${%localizedString (MAC Address) #}\$</td> MAC Address is the row heading. This heading is translated if possible.
20	<td regname="MAC Address"></td> This displays the value of the read-only named register MAC Address.
23	<td>\${%localizedString (Ethernet Device Name) #}\$</td> Ethernet Device Name is the row heading. This heading is translated if possible.
24	<td><input name="Ethernet Device Name" type="text" /></td> This displays the instantaneous value of the configurable named register Ethernet Device Name in a text-edit field. The type must match the named register type, in this case, an alphanumeric string.

Line #	Description
27	<pre><td>\${%localizedString (IP Address) #}\$</td></pre> <p>IP Address is the row heading. This heading is translated if possible.</p>
28	<pre><td><input name="IP Address" type="text" /></td></pre> <p>This displays the instantaneous value of the configurable named register IP Address in a text-edit field. The type must match the named register type, in this case, an alphanumeric string.</p>
34	<pre><h3 target="sample-advanced"></pre> <p>This creates the second webpage content pane. Sample-advanced is the name of the webpage content. This name must be unique.</p> <pre> \${%localizedString (Advanced Settings) #}\$</h3></pre> <p>Advanced Settings is the title of the webpage content pane. This title is translated if possible.</p>
35	<pre><div id="sample-advanced"></pre> <p>This must match the name of the webpage content in line 34.</p>
42	<pre><td>\${%localizedString (TCP Keep Alive Minutes) #}\$</td></pre> <p>TCP Keep Alive Minutes is the row heading. This heading is translated if possible.</p>
43	<pre><td><input type="text" name="TCP Keep Alive Minutes" class="small" /></pre> <p>This displays the instantaneous value of the configurable named register TCP Keep Alive Minutes in a text-edit field. The type must match the named register type, in this case, an alphanumeric string.</p> <pre></td></pre> <p>This displays the units that the meter has defined for the named register TCP Keep Alive Minutes. NOTE: There are no defined units for TCP Keep Alive Minutes, so no units are displayed.</p>
46	<pre><td>\${%localizedString (Enable Web Server) #}\$</td></pre> <p>Enable Web Server is the row heading. This heading is translated if possible.</p>
47	<pre><td><select name="Enable Web Server"></select> </td></pre> <p>Enable Web Server is the named register that is displayed. Named registers are listed in the meter's registers map. The type must match the named register type, in this case, an enumerated value that is displayed as a drop-down list.</p>
61	<pre>SetupPane.init ('formSampleSettings');</pre> <p>This must match the webpage content name from line 4.</p>
62	<pre>formChangeDetection.initFormChangeDetection ('#formSampleSettings', '#dialogFormChanges');</pre> <p>This must match the webpage content name from line 4. This HTML code updates all of the webpage's values.</p>

Display

Display overview

The display allows you to view meter data and perform basic configuration.

NOTE: The display backlight dims after a defined period of inactivity. When the meter detects an unacknowledged active high priority alarm, the display flashes until the alarm is acknowledged.

Display

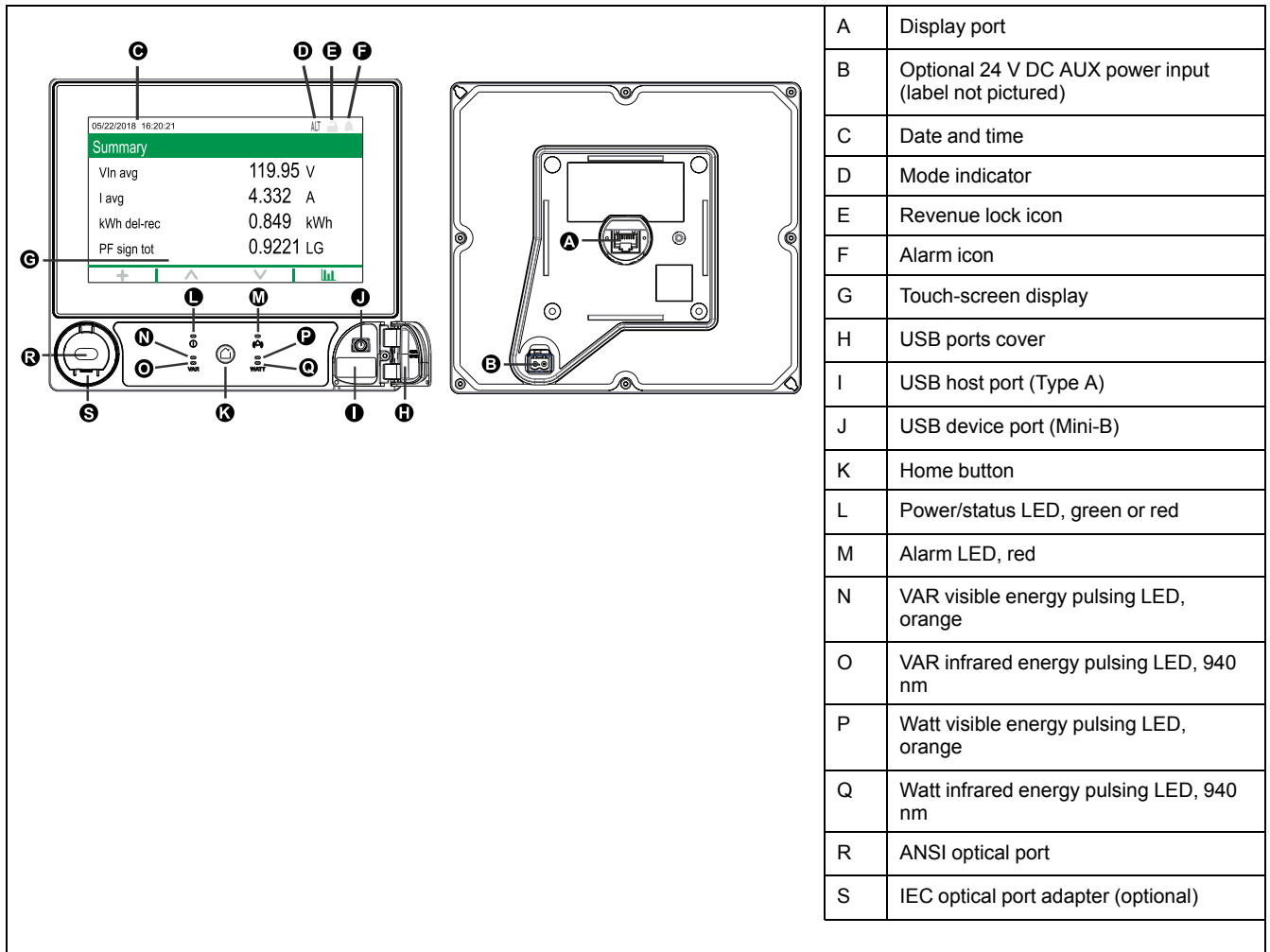

Mode indicator

The display mode indicator identifies whether the meter is in normal (NORM), alternate display (ALT) or test (TEST) mode.

Home button

Press the Home button to access display menus or return to the active menu.

Press the Home button twice to access the last data screen displayed or the Summary screen, if in ALT mode.

The function of the home button varies:

- NORM mode: Displays Energy and Demand screens.
- ALT mode: Displays ALT mode display and setup menus. Select **Normal Display Mode** from the ALT display menu to exit the ALT display mode.
- TEST mode: Displays Test mode and Setup menus.

- Setup Menu: Displays active menu item.

Revenue lock icon

The revenue lock icon indicates the lock status of the meter.



When gray and open, the meter is unlocked. When green and closed, the meter is locked. You can lock and unlock your meter using the revenue lock switch located on the body of your meter.

Alarm icon

The alarm icon indicates the highest level and state of alarms detected by your meter.

For example, if the meter detects a low priority and a high priority active alarm, the alarm icon indicates a high priority active alarm.

NOTE: Alarms can only be viewed and acknowledged through your display.

Icon	Description
	Active alarm indicator: <ul style="list-style-type: none"> • Red: high priority alarm state detected • Yellow: medium priority alarm state detected • Blue: low priority alarm state detected The alarm indicator flashes until you acknowledge the alarm. The alarm indicator changes to the historic alarm indicator of the appropriate level when the alarm state is no longer detected by the meter. NOTE: Your display backlight flashes for unacknowledged high priority active alarms.
	Unacknowledged historic alarm indicator: <ul style="list-style-type: none"> • Red: unacknowledged high priority historic alarm • Yellow: unacknowledged medium priority historic alarm NOTE: Low priority historical alarms are not indicated. The active alarm indicator changes to the historic alarm indicator of the appropriate level when the alarm state is no longer detected by the meter.
	No active or unacknowledged high or medium priority historic alarms

Alarm and status LED indicators

Your meter has alarm and status LEDs.

These LEDs cannot be configured for other uses.

LED	Description
Status	Off: unpowered Steady green: normal operation Flashing red: no communications (remote display only) Steady red: firmware upgrade required (remote display only) Flashing red/green: startup or firmware upgrade sequence in progress
Alarm	Off: no active or unacknowledged historic alarms On: acknowledged active alarm Flashing: active alarm NOTE: The display backlight flashes for unacknowledged high priority active alarms.













Related Topics

- Default energy pulsing LED sources

Display icons

Icons are displayed on the bottom of the screen.

NOTE: If the icon is gray, the function is not available.

Icon	Description
	Tap More to access additional screens.
	Tap Left arrow to select item to the left or to return to the previous screen.
	Tap Right arrow to select item to the right.
	Tap Up to navigate menu items or screens.
	Tap Down to navigate menu items or screens.
	Tap Select to confirm selection or change.
	Tap Cancel to exit and return to previous screen.
	Tap Graphic to view graphical representation of data.
	Tap Numeric to view numerical representation of data.
	Tap Info to display screen details.
	Tap Edit to enter parameter values or select setting.
	Tap Check Box to perform an action.
	Tap double-arrow to select parameter.

More screens access

You can access additional screens.

Pressing the More icon opens a list of additional screens related to the active screen. Press cancel to close the list. If you do not select a screen, you are returned to the last data screen displayed.

Overrange indication

If any value measured by the meter is too large to fit on the display, the meter initially reduces the size of the text to try and make the value fit.

If the value is still too large to be displayed, the meter truncates the value starting with the least significant digit, and encloses the truncated value in a red box.

Interrupted display data

Display data is updated by the meter every second during normal operation.

If the display detects a data interruption, the following occurs:

- Date/time information is cleared.
- Display mode indicator is set to normal (NORM) mode.
- Revenue lock icon indicates a locked state (green and closed).
- Alarm icon indicates an unacknowledged high priority historic alarm (red outline bell).
- All parameter labels and associated parameter data are cleared.

Display screen title bar and display icons are retained.

Auto-scaling feature

Measurement units on the meter display and webpages automatically scale, depending on the value of PT Primary and CT Primary.

Voltage units are scaled based on the PT Primary value:

PT Primary value	Units or scaling
< 1000	V
1000 to 999,999	kV

Current units are scaled based on the CT Primary value:

CT Primary value	Units or scaling
< 1000	A
1000 to 999,999	kA

Power units are scaled according to the value of (CT Primary x PT Primary x 3):

(CT Primary x PT Primary x 3) value	Units or scaling
< 1,000,000	kW, kVAR or kVA
1,000,000 to 999,999,999	MW, MVAR or MVA
≥ 1,000,000,000	GW, GVAR or GVA

Display screens

Display modes

Your meter has three display modes and provides access to your meter's setup screens:

- Normal Mode Screens (NORM). In Norm mode, your meter automatically scrolls through a series of customizable display screens. You can add or remove Norm mode display screens. If there are no Norm mode display screens, the meter displays a message stating that there are no available screens. To exit Norm mode, press the home button to access the display modes selection screen.
- Alt Display Mode (ALT): In Alt mode, you can navigate to view the different alternate screens. You cannot modify the default Alt mode display screens, but you can add custom screens. To exit Alt display mode, select **Normal Display Mode** to access the display modes selection screen.

- **Test Mode (TEST):** In Test mode, you can manually scroll through a series of default screens. To exit Test mode, press the home button and select **Exit Test Mode**.

NOTE: In Test mode, your meter's billing quantities stop accumulating and the data is sent to special test mode registers. These registers are cleared when you exit Test mode.

Access your meter's setup screens by pressing the home button in NORM, ALT or TEST mode. To exit the setup screens, press the home button.

Norm mode display menu

The Norm mode display screens show measured and calculated information about the power system being monitored.

NOTE: Your meter's menus may appear slightly different than shown depending on your display settings.

Normal Mode Screens	
	Active Energy
	Reactive Energy
	Apparent Energy
	Peak Demand Delivered
	Peak Demand Reset Count

Alt mode display menu

The alt mode display menu allows you to view data screens and access the setup menu.

NOTE: Display menus may appear slightly different than shown depending on your display settings.

Summary		Summary						
Alarms	Active Alarms	Active Alarms	<input checked="" type="checkbox"/> Acknowledge All	Alarm Details				
	Historical Alarms	Historical Alarms	<input checked="" type="checkbox"/> Acknowledge All	Alarm Details				
Basic Readings	Voltage	Volts L-L	+ Volts L-L Average	Volts L-L Min	Volts L-L Max			
		Volts L-N	+ Volts L-N Average	Volts L-N Min	Volts L-N Max			
		Volts Unbalanced						
	Current	Current	+ I Average	I Min (Ia Ib Ic)	I Min (I4)	I Max (Ia Ib Ic)	I Max (I4)	
Power	Frequency	Frequency						
	Power Summary	Power Total	+ Power Total Min	Power Total Max				
		Power Phase A						
		Power Phase B						
		Power Phase C						
	Demand	Total Demand Delivered	+ Peak Demand Delivered Total	TOU Peak Demand Delivered (A-B)	TOU Peak Demand Delivered (C-D)			
		Total Demand Received	+ Peak Demand Received Total	TOU Peak Demand Received (A-B)	TOU Peak Demand Received (C-D)			
	Power Factor	Power Factor	+ Power Factor Total Min	Power Factor Total Max				
Energy		Energy Delivered-Received						
		Energy Delivered	+ TOU Energy Delivered A&B	TOU Energy Delivered C&D				
		Energy Received						
Events		Events	Event Details					
Power Quality	EN50160	EN50160 Power Frequency	+ Power Frequency Compliance					
		EN50160 Nominal Supply Voltage						
		EN50160 Supply Voltage - V1	+ Voltage Compliance - V1					
		EN50160 Supply Voltage - V2	+ Voltage Compliance - V2					
		EN50160 Supply Voltage - V3	+ Voltage Compliance - V3					
		EN50160 Volts Unbalance	+ Volts Unbalance Compliance					
		EN50160 Volts Harmonics - V1	+ Volts Harmonics Compliance - V1					
		EN50160 Volts Harmonics - V2	+ Volts Harmonics Compliance - V2					
		EN50160 Volts Harmonics - V3	+ Volts Harmonics Compliance - V3					
		EN50160 Voltage Flicker - V1	+ Volts Flicker Compliance - V1					
		EN50160 Voltage Flicker - V2	+ Volts Flicker Compliance - V2					
		EN50160 Voltage Flicker - V3	+ Volts Flicker Compliance - V3					
		Harmonics	Voltage THD	+ V1 Harmonics	V2 Harmonics	V3 Harmonics		
			Current THD	+ I1 Harmonics	I2 Harmonics	I3 Harmonics	I4 Harmonics	
		Phasors	Phasor Diagram					
	Inputs/Outputs	Digital Inputs	Digital Inputs					
	Digital Outputs	Digital Outputs						
	Analog Inputs	Analog Inputs						
	Analog Outputs	Analog Outputs						
Nameplate		Nameplate						
Custom Screens		See Creating custom display screens section for details.						
Normal Display Mode	Normal Mode Screens							
	Alt Display Mode							
	Test Mode							
	Setup Menu							
Setup Menu		See Setup menu section for details.						

Alt mode data display screens

Your meter’s alt mode display screens show measured and calculated information about the power system being monitored.

NOTE: Minimum, maximum (peak), average and time of use (TOU) values are typically accessed by pressing More to open a list of additional screens.

Menu	Menu screens	Content
Summary	Summary	Power system summary
Alarms	Active alarms, historical alarms	Active and historical alarms can be viewed and acknowledged.
Basic readings	Voltage, current, frequency	<ul style="list-style-type: none"> Power system voltage (line-to-line or line-to-neutral), current and frequency values. Average, minimum and maximum values are also provided.

Menu	Menu screens	Content
Power	Power summary, demand, power factor	<ul style="list-style-type: none"> Per-phase and total kW, kVAR and kVA values, along with minimum and maximum values. Delivered and received demand values including peak demand. Per-phase and total power factor along with minimum and maximum values.
Energy	Energy	Energy delivered-received, delivered and received.
Events	Events	Meter event log entries listing and details.
Power quality	EN50160, harmonics, phasors	<ul style="list-style-type: none"> EN50160 values. Voltage and current harmonics, with individual and total harmonic values. Phasor diagram with magnitude and angle values.
Inputs/outputs	Digital inputs, digital outputs, analog inputs, analog outputs	Digital and analog I/O values and counts.
Nameplate	Nameplate	Meter model, firmware version and serial number, along with owner and tag information.
Custom screens	—	Custom screens
Normal Display Mode	—	Access to the display mode selection screen.
Setup Menu	—	Access to the setup menu screens.

Setup menu

Meter configuration can be performed through the display.

Configure your meter's security settings to allow front panel (display) programming in order to set up the meter using the display.

NOTE: Your display may appear differently than shown, depending on your meter's power system, configuration and display settings.

NOTE: Some setup parameters cannot be configured when revenue security is enabled.

Setup Menu	
Meter Setup	Volts Mode Volts Mode PhaseOrder PT/CT Setup PT Primary PT Secondary CT Primary CT Secondary I4 Primary I4 Secondary Voltage Polarity Setup Va Polarity Vb Polarity Vc Polarity Current Polarity Setup Ia Polarity Ib Polarity Ic Polarity I4 Polarity Nominal Values Nominal Voltage Nominal Current Nominal Frequency
Ethernet Port Enable Setup	Ethernet Port Enable Setup <input checked="" type="checkbox"/> Enable/Disable
Communications Setup	IPv4 Assignment Mode Setup Stored IPv4 Address Setup Stored IPv4 Address Stored IPv4 Subnet Mask Stored IPv4 Gateway MAC Address IPv6 Link Local Address IPv6 Assignment Mode Setup Acquired IPv6 Global Address Ethernet Device Name DNS Setup COM1 Setup Protocol Baud Rate RX Timeout Unit ID Serial Port RS485 Bias COM4 Setup Protocol Baud Rate RX Timeout Unit ID Serial Port RS485 Bias NTP Address SMTP Address
Display Setup	Screen Setup Backlight Timeout Label & Symbol Setup Phase Label Measurement Symbols PF Convention Numeric Format Setup Digit Grouping Voltage Resolution Current Resolution Power Resolution
Date/Time/Clock Setup	Date & Time Setup Time Format Date Format Timezone O set DST O set Clock Setup Clock Source Time Sync Source Time Sync Type
Alarm Setup	Alarm Setup <input checked="" type="checkbox"/> Enable/Disable
Language Setup	Language Setup
Time of Use Setup	TOU Active Rates TOU Season
Resets	Resets <input checked="" type="checkbox"/> Select for Reset
Password Setup	Password Setup

Meter setup using your display

Navigate to Setup screens and enter parameters to configure your meter.

Your meter’s default display password is 0 (zero).

NOTE: Your meter locks you out of display configuration after you have exceeded the maximum number of attempts to enter a password.

The following example shows how to use the navigation buttons to select parameters, enter numeric information or select parameter values from lists.

NOTE: Your display may appear differently than those shown, depending on your meter’s power system and display and localization settings.

Example: setting volts mode and PT/CT ratios

Use the display navigation buttons to set your meter’s volts mode and PT ratios.

NOTE: Potential transformers (PT) are also known as voltage transformers (VT).

1. Press to display the menu. Press until **Setup Menu** is highlighted.

Press to display the **Setup Menu**. The **Setup Menu** lists the setup selections on your meter.

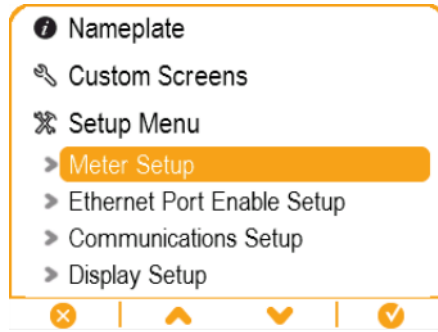

2. Press or to highlight the different setup menu selections. Highlight **Meter Setup** and press to select the meter setup screens. The **Volts Mode** setup screen is displayed.

3. Press to highlight **Volts Mode**. Press to edit the volts mode. The **Enter Password** screen is displayed.

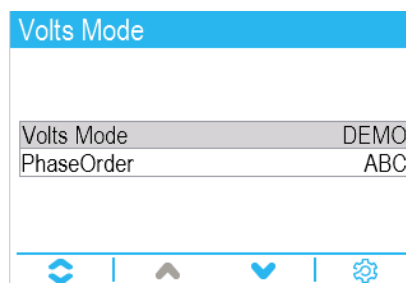

4. Press to change the value of the highlighted digit (0 - 9). Press to go to the next digit. Press to enter your password using the onscreen keyboard. The **Volts Mode** configuration screen is displayed.

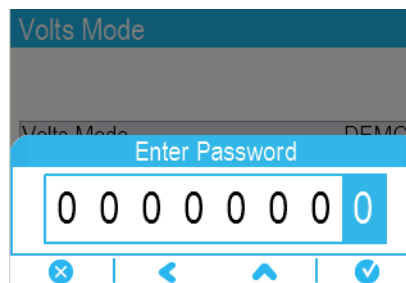

5. Press or to highlight the desired volts mode from the list, in this case, 3W-WYE. Press to select the highlighted volts mode. A confirmation screen is displayed, showing your meter's previous setting and newly selected setting.

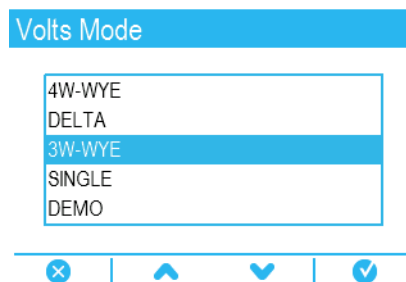

6. Press to confirm, and the new setting is applied to your meter. Press to cancel and maintain your meter's original setting.

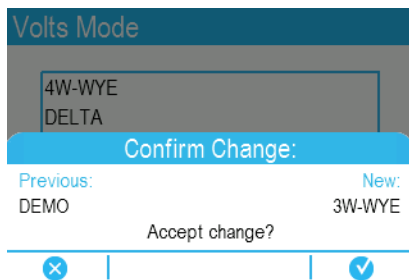

- In the **Volts Mode** screen, press to go to the **PT/CT Setup** screen.
- In the **PT/CT Setup** screen, press to highlight the potential transformer (PT) or current transformer (CT) value for editing. Press to edit the highlighted value.

NOTE: If you have exceeded the password timeout period, you are prompted to enter your meter’s display password.

PT/CT Setup

	Primary	Secondary
PT	120.00	120.00
CT	5.000	5.000
I4 CT	5.000	5.000



- Press to change the value of the highlighted digit (0 - 9). Press to go to the next digit. Press to enter the new value. When the confirmation screen is displayed, press to confirm the new value or to revert to the original value.

Related Topics

- Factory default settings

Display setup

You can configure basic display parameters using the display.

Screen setup

Parameter	Values	Description
Backlight Timeout	0 to 720	Specifies how many seconds the display’s backlight remains lit after the last button press

Label & symbol setup

Parameter	Values	Description
Phase Lbls	ABC, 123	Sets the voltage and current phase labels
Measurement Symbols	IEEE, IEC	Specifies whether IEEE or IEC measurement symbols are applied to displayed values
PF Convention	IEEE, IEC	Specifies whether IEEE or IEC power factor conventions are applied to displayed values

Numeric format setup

Parameter	Values	Description
Digit Grouping	1000.0, 1,000.0, 1 000,0	Specifies how digits are grouped for display
Volts Resolution	1., 1.X, 1.XX, 1.XXX, 1.XXXX	Specifies the number of decimal places displayed for voltages
Current Resolution	1., 1.X, 1.XX, 1.XXX, 1.XXXX	Specifies the number of decimal places displayed for currents
Power Resolution	1., 1.X, 1.XX, 1.XXX, 1.XXXX	Specifies the number of decimal places displayed for power and energy measurements

Language setup

Select the language to be shown on the display.

By default, your meter has the following languages:

- English
- Spanish
- French
- German
- Italian
- Portuguese
- Russian
- Chinese (simplified)

Creating custom displays using ION Setup

You can use ION Setup to create new custom displays.

1. Start ION Setup.
2. Open the Setup Assistant for your meter.
3. Navigate to **Displays**.
4. Select **Displays** from the **Front Panel** tab and click **Edit**. ION Setup loads your meter's display information into the **Display Editor** screen.
5. Select the display mode of the custom screens from the dropdown list, and rename, delete, or change the order of custom displays.
 - a. Click **New** to add a new display screen in the selected display mode.
 - b. Click **Edit** to bring up the **Display setup** screen, where you can configure new or existing custom displays.
6. Configure your screen.
 - **Screen Type**: Specify the number of parameters displayed on the screen.
 - **Screen Title**: Enter the title to be shown at the top of your custom display.
7. Click **Edit** to select the displayed parameters. The number of parameters displayed is determined in the **Screen Type** selection described above.
8. Select your digit display properties.
 - **Resolution**: Specifies the number of decimal places displayed.
 - **Last Digit**: Specifies if the last digit is rounded or truncated.
9. Click **Send** to save the changes in the meter.

Display scaling

You can customize the units for metered values shown on the display and webpages.

You can configure the units for voltage, current, power and energy values shown on the display and webpages from their default units, and you can set the resolution for the display. To identify which values will have the modified units, refer to the display and web units information in your meter’s Modbus map, available from www.schneider-electric.com.

Configuring display units scaling using ION Setup

You can customize the units for metered values shown on the display and webpages using ION Setup.

Configuring display units scaling is an advanced procedure that requires in-depth knowledge of your meter, its underlying architecture, and the system in which it is installed.

To identify which values will have the modified units, refer to the display and web units information in your meter’s Modbus map, available from www.schneider-electric.com.



NOTE: Custom units and resolution settings are automatically adjusted for current and voltage values to help prevent your meter’s display from showing incorrect zero values.



1. Start ION Setup.
2. Connect to your meter in advanced mode.
3. Navigate to the Display Options Modules folder and double-click on the module in the righthand pane.
The **Display Options** screen is displayed.
4. Select the **Setup Registers** tab.
5. Select the display units you want to configure: Voltage Units, Current Units, Power Units or Energy Units. Click **Edit**.
A unit selection screen is displayed.
6. Select the desired units from the dropdown list, and click **OK**.
7. When you have finished configuring the display units, click **Send** to send your changes to the meter and close the **Display Options** screen.

See the ION Reference, available from www.schneider-electric.com, for more information about the Display Options module and your meter’s ION architecture.

Remote display troubleshooting icons

The remote display shows troubleshooting icons in addition to the meter’s status LED information.

Icon	Description
	Your remote display is connecting to your meter.
	Your remote display cannot communicate to your meter. Check the connection between your meter and the display. Check the meter’s status LED to confirm that the meter is operating normally.

Icon	Description
	Your remote display needs updated firmware for compatibility with your meter.
	Your remote display is downloading a firmware upgrade. Do not disconnect your remote display from your meter.
	Your remote display is undergoing a firmware upgrade. Do not disconnect your remote display from your meter.

Security

Security overview

Your Schneider Electric product is equipped with security-enabling features.

These features arrive in a default state and can be configured for your installation needs. Please note that disabling or modifying settings within the scope of these individual features can impact the overall security robustness of the device and ultimately the security posture of your network in either positive or negative ways. Review the security intent and recommendations for the optimal use of your device's security features.

Products are hardened to increase security robustness. This is an ongoing process consisting of secure development practices, inclusion of security features and testing at our security test facilities. Following system hardening best practices is also necessary to help ensure your overall system security.

See the *Cybersecurity Hardening Best Practices* white paper for suggested best practices.

Security features on your device

Your device comes with security features that you can configure to help protect against unauthorized configuration and access to your device's data through its user interfaces or communications.

Enable/disable communication ports

You can disable physical communication ports when they are not in use.

These can be disabled through the display, ION Setup or through the meter's webpages.

Leaving unused ports open provides additional attack surfaces for a potential attacker. Minimizing the number of ports open on the device reduces the likelihood of unauthorized intrusions by providing fewer entry points.

Related Topics

- Disabling serial communications using ION Setup
- Disabling serial communications using the meter webpages
- Disabling serial communications using the display

Network port control

This feature provides you with the ability to enable and disable individual network ports and to change port numbers from their default values.

Leaving unused ports open provides additional attack surfaces for a potential attacker. Minimizing the number of ports open on the device reduces the likelihood of unauthorized intrusions by providing fewer entry points.

Once your meter is configured, all network ports related to unused protocols should be placed in the OFF state/position. Minimize the number of open ports, temporarily opening ports for activities such as periodic firmware / software downloads when required.

Network ports that remain open should be changed from their default values wherever possible.

Related Topics

- Network protocol control using ION Setup
- Network protocol control using the meter webpages
- Network protocol control using the meter display
- Protocols, ports and connections

Revenue and billing security features

Selected meter models support additional hardware and firmware locking to prevent unauthorized access to revenue-related parameters and settings.

Event logging

Your meter records meter functions, events and changes to meter parameters and logs them as entries in the event log.

Event logs entries are timestamped and user-related events are associated with the username that was logged into the meter. Security-related events such as resets, successful or unsuccessful login attempts, user lockout or meter configuration changes are also recorded in the event log along with a timestamp and the username associated with the event. The event log can be used to monitor system events, assist in confirming security compliance, or assist in tracking unauthorized intrusion attempts.

Related Topics

- User triggered event log entries

Syslog

This feature allows you to push event log information to a centralized syslog server.

When the event log of a meter is full, new log entries can overwrite existing entries. By pushing the event log information to a syslog server, older event log information can be preserved and used as part of an information storage and retrieval strategy.

Related Topics

- Configuring Syslog network settings using ION Setup

Advanced security access using the display

Advanced security is available through the meter's display.

When advanced security is enabled on your meter, user privileges created through ION Setup are enforced through the meter's display. When advanced security is enabled, changes to meter configuration are associated with the username that is logged into the meter. The advanced security password used to access the meter uses an expanded character set, allowing for a more robust password.

HTTPS

HTTPS uses Transport Layer Security (TLS) encryption to secure the communications channel and protect exchanged data between the meter and the web client. When configured to use HTTPS, the meter uses the self-signed certificate installed on its webserver.

NERC CIP

North American Electric Reliability Corporation (NERC) Critical Infrastructure Protection (CIP) is a set of standards and requirements designed to help protect the North American power generation and transmission system and covers aspects such as critical cyber asset identification, electronic security perimeters, and systems security management.

This meter has incorporated security features that allow it to be part of NERC CIP compliant facility. For example, the security features of this meter include user accounts with configurable passwords and permissions; network port control configuration; security access and event log replication to an external server; and digitally signed firmware.

For more information about NERC or the CIP standards, go to the North American Electric Reliability Corporation’s website at <http://www.nerc.com>.

Security recommendations and best practices

Recommended security configuration

Recommended security configuration settings help improve security on your meter.

- Ensure that your meter requires a password for configuration through the display or communications.
- Configure the protocol lockouts to help minimize access to your meter.
- Enable advanced security on your meter.
 - Configure users and passwords to help minimize access to your meter.
- Disable communications for all unused network ports and protocols.
- Change the connection ports from their default values wherever possible.
- Save a copy of your meter’s ION Setup security configuration (*.scf) file in a secure location for future reference or troubleshooting. Your meter’s security configuration file can be loaded onto other meters of the same type to configure their security settings. Security files are encoded.
- For the highest level of security, use a revenue-locked meter with advanced security enabled and configured for minimum access.
- Set your meter’s time synchronization source to a secure communications port, and disable time synchronization on all other ports.

Password best practices

Recommended password best practices help to improve security on your meter.

- Change your meter’s password from the default value.
- Make your meter’s passwords as complex as possible.

NOTE: Make sure that the user password you enter is compatible with the software used to communicate with your device.
- Schedule regular changes to your meter’s passwords.
- Record your meter’s passwords in a secure location.

If your meter’s user access information is lost, you must return the meter to the factory, where your meter is reset to its factory defaults and all logged data is lost.

<i>NOTICE</i>
<p>DATA LOSS</p> <p>Record your device's user and password information in a secure location.</p> <p>Failure to follow these instructions can result in equipment damage.</p>

Standard and advanced security features

Security settings allow you to configure security features on your meter.

Parameter	Standard/ advanced	Details
Meter password	Standard/ advanced	The meter's password is used to confirm user access when configuring the meter through the display or over communications. The default meter password is 0 (zero).
Active web server	Standard/ advanced	This option allows you to enable or disable your meter's webpages.
Allow web server programming	Standard/ advanced	This option allows you to enable or disable the ability to configure your meter using the meter's webpages. NOTE: To enable Allow web server programming , you must have active web server enabled.
Allow Modbus programming	Advanced only	This option can only be enabled in advanced security and is disabled for standard security.
Allow front panel programming	Standard/ advanced	This option allows you to enable or disable the ability to configure your device using the display.
Allow broadcasting time synchronization	Advanced only	This option can only be disabled in advanced security and is enabled for standard security.
Protocol lockout	Standard/ advanced	This option allows you to configure the number of access attempts before lockout, lockout duration and meter access event priorities.

Advanced security user configuration

Advanced security allows you to configure users with specific access levels and passwords.

Security configuration process

The security configuration process has four basic steps: review security recommendations, set basic security options, configure communications protocol lockout settings, and configure users.

1. Review security recommendations
2. Set basic security options
 - Change the meter password.
 - Disable broadcasting time synchronization (advanced security only).
 - Enable/disable display (front panel) and Webserver programming.
 - Enable/disable Modbus programming (advanced security only).
3. Configure communications protocol lockout options
 - a. Configure protocol-specific settings:
 - Set the number of attempts before the protocol is locked out.
 - Set the session timeout.
 - b. Configure global lockout settings:
 - Enter a lockout duration.
 - Set the priority of meter access events.
4. Configure users (advanced security only)
 - Determine user access.
 - Set user passwords.

Communications protocol lockout overview

The communications protocol lockout security feature allows you to set the number of invalid login attempts that each user can make using a particular protocol and communications method before being locked out (a user is defined as a user login and password combination).

For protocols that are not session-based (ION), you can configure how often the device registers invalid login attempts by configuring the session timeout. You can also configure the lockout duration for all configurable protocols.

Session timeout specifies the active duration for a protocol; during this time, repeated invalid login attempts using the same USER/password combination are not registered (repeated invalid attempts with different combinations are still registered). Session timeout only applies to protocols which are not session-based (ION) and send credentials with each packet, and should be configured to help prevent accidental lockouts and filling the meter's event log with protocol access events

NOTE: If protocol lockout is set to 0 (zero) there is no limit to the number of invalid login attempts and the protocol will never be locked out. However, the invalid login attempt events are recorded if the meter is configured to record invalid access attempts.

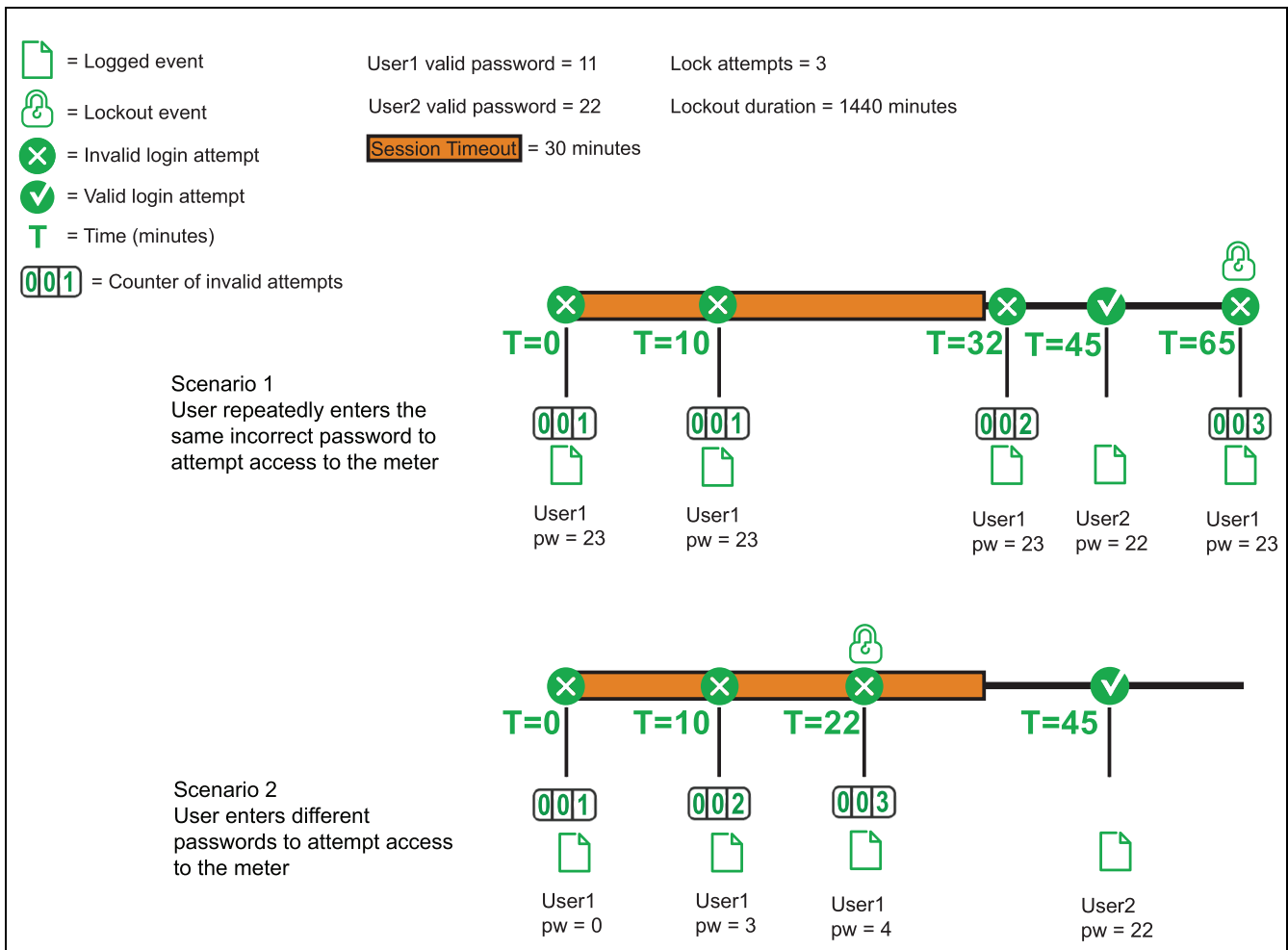

Once a user is locked out, the device will not accept login attempts from that user on that protocol and communications method until the lockout duration has passed. Invalid login attempts accumulate until the user has completed a valid login or is locked out. If the user enters the correct USER/password combination before being locked out, the invalid attempt counter is reset to zero. Even if the user is locked out using ION over Ethernet, that user can still access the device by entering the correct USER/password combination over a different protocol and communications method.

Related Topics

- Configuring standard security using ION Setup

Standard security password setup

It is strongly recommended that you change your meter’s password from the default value of 0 (zero).

Your meter’s username and password cannot be retrieved if lost. If you lose your meter’s user access information, you will not be able to change any settings or access any data that requires this login information.

NOTICE
<p>LOSS OF ACCESS</p> <p>Record your device's user and password information in a secure location.</p> <p>Failure to follow these instructions can result in loss of access to the device.</p>

Parameter	Range	Description
Meter Password	0 – 99999999 (max 8 characters)	<p>Sets the password that must be entered in order to configure parameters using the meter’s display or ION Setup.</p> <p>This is also the password used to access the meter’s webpages when standard security is enabled.</p> <p>NOTE: Leading zeroes are ignored.</p>

Advanced security password setup

Advanced security supports multiple users with different access levels, so it is highly recommended to maintain a record of all the user/password combinations and store that record in a secure location.

Your meter’s username and password cannot be retrieved if lost. If you lose your meter’s user access information, you will not be able to change any settings or access any data that requires this login information.

NOTICE
<p>LOSS OF ACCESS</p> <p>Record your device's user and password information in a secure location.</p> <p>Failure to follow these instructions can result in equipment damage.</p>

User names are pre-programmed in the meter, starting with USER1, USER2, and so on. Advanced security allows you to set either a numeric or alphanumeric password.

Password type	Range	Notes
Numeric	0 – 99999999 (max 8 characters)	Leading zeroes not allowed
Alphanumeric	Any combination of numbers, letters and symbols (max 6 characters)	<ul style="list-style-type: none"> • Limited to standard printable ASCII characters (ASCII codes 33 – 126) • Spaces not allowed

Example

	Facility manager	Plant engineer	Worker1	Worker2	Guest
User name	USER1	USER2	USER3	USER4	USER5
Password	FacM1!	PE321!	Emp1!	Emp2!	123456789
Full meter setup	Yes	No	No	No	No
Security setup	Yes	Yes	No	No	No
Test mode	Yes	Yes	Yes	No	No
Communications setup	Yes	Yes	Yes	Yes	No
Peak demand reset	Yes	Yes	Yes	Yes	No
Time sync	Yes	Yes	Yes	Yes	No
Read access	Yes	Yes	Yes	Yes	Yes

Advanced security username and password through the display

You can enter your username and password on the meter's display when advanced security is enabled.

When you attempt to change a setting through the display of a device that has advanced security enabled, you are prompted to provide the username and password created using ION Setup. If the access level associated with the user is not sufficient to change the setting, you cannot modify the setting and the message INVALID SECURITY LEVEL OR INVALID ACCESS is displayed.

NOTE: Only standard printable ASCII characters are allowed for passwords created in ION Setup.

Changing your meter password using the display

You can change your meter password using your meter's display.

The meter password is also used as the webpage password if standard security is enabled.

NOTE: If advanced security is enabled, you must enter a valid username and password to change the meter password using the display.

1. Go to **Setup Menu > Password Setup**.
2. Configure your meter password.

Configuring standard security using ION Setup

You can fully configure standard and advanced security on your meter using ION Setup.

In order to change security settings, you must be logged into ION Setup with an appropriate ION Setup user level. You must also have the appropriate meter-level security access to configure meter security.

1. Start ION Setup.
2. Open the Setup Assistant for your meter.
3. Navigate to **Security**. Select Security Mode and click **Edit**. The open dialog box appears.

4. Select the appropriate security configuration file (*.scf) to configure your meter:
 - Standard: allows you to configure basic security and communications protocol lockout.
 - Advanced: includes the standard security features and adds user access/password security settings.
5. The standard options or advanced options configuration screen appears. Configure the security parameters as required, some parameters can only be configured using advanced security.

Click **Next** to configure protocol access information. The protocol lockout screen is displayed.
6. In the protocol lockout screen select the protocols that you want to be protected by the protocol lockout function. Select each protocol and click **Edit** to configure the protocol-specific parameters.
7. Enter the lockout duration (in minutes).
8. Click **Events** to configure user access event priorities. The Event Priorities screen appears.
9. Configure the user access event priorities.

- If you have selected standard security, click **Finish**. You are prompted to save your security configuration to a file which can be loaded onto other meters.

NOTE: If you chose to save your security file, enter a descriptive name and click **Save**. It is recommended that you do not overwrite the default security files.

If you have selected advanced security, click **Next** to configure user access and passwords.

Security parameters available using ION Setup

Parameter	Standard/advanced	Details
Meter password	Standard/advanced	Default meter password is 0 (zero).
Active web server	Standard/advanced	This option allows you to enable or disable your meter's webpages.
Allow web server programming	Standard/advanced	This option allows you to enable or disable the ability to configure your meter using the meter's webpages. NOTE: To enable allow web server programming, you must have active web server enabled.
Allow Modbus programming	Advanced only	This option can only be enabled in advanced security and is disabled for standard security.
Allow front panel programming	Standard/advanced	This option allows you to enable or disable the ability to configure your device using the display.
Allow broadcasting time synchronization	Advanced only	This option can only be disabled in advanced security and is enabled for standard security.

Protocol-specific security parameters available using ION Setup

Parameter	Values	Description
Protocol lockout	0 - 255	The number of invalid login attempts before access is denied. If protocol lockout = 0, there is no limit to the number of invalid login attempts and the protocol will never be locked out.
Session timeout	1 - 43200 minutes (30 days)	The interval between access checks for non-session based protocols.

Related Topics

- Recommended security configuration
- Protocols, ports and connections

Configuring users and passwords using ION Setup (advanced security only)

Use ION Setup to configure users and passwords.

In order to change security settings, you must be logged into ION Setup with an appropriate ION Setup user level. You must also have the appropriate meter-level security access to configure meter security.

You must have configured the standard security settings on your meter using ION Setup.

This task assumes that you are in the user configuration screen in the security wizard in ION Setup.

- In the user/passwords screen, select (check) the user that you want to configure to view the user access options.

2. Select the appropriate values to configure the user’s access.
 Some access levels require that multiple access options be selected. For example, if you enable Security Config Access, Full Meter Config Access is also enabled.
3. Select the user and click **Password**.
 The password entry screen appears.
4. Enter the desired password and click **OK**.
5. Continue configuring user access and passwords for each unique user of the meter.

NOTE: Select **Show password** when a user is selected to display the password associated with that user. This feature is intended to help ensure that the correct password is entered for each user.

6. Click **Finish** to save your security configuration to the meter. You are prompted to save your security configuration to a file which can be loaded onto other meters.

If you chose to save your security file, enter a descriptive name and click **Save**. It is recommended that you do not overwrite the default security files.

Advanced security access levels

Access	Description
Time sync	The user can set the meter’s time and time synchronization parameters.
Read	The user can view all parameters except the security configuration.
Peak demand reset	The user can reset peak demand values.
Comm config	The user can configure the communication settings.
Test mode	The user can put the meter into test mode (not applicable to all devices).
Full meter config	The user can configure all aspects of the meter except demand resets, test mode or security.
Security config	The user can configure security.

Loading a security configuration file using ION Setup

You can load an existing security configuration file (*.scf) onto your meter using ION Setup.

The *.scf file can be a configuration for either standard or advanced security and must be from the same model of meter.

In order to change security settings, you must be logged into ION Setup with an appropriate ION Setup user level. You must also have the appropriate meter-level security access to configure meter security.

1. Start ION Setup.
2. Open the Setup Assistant for your meter.
3. Navigate to **Security**. Select **Security Mode** and click **Send**. The **Open** dialog box appears.
4. Navigate to the location of the *.scf file you want to load onto your meter. Select the *.scf file and click **Open**. The *.scf file is loaded onto your meter.

Alarms and alerts

Alarms overview

An alarm is the meter's means of notifying you when an alarm condition is detected, such as an error or an event that falls outside of normal operating conditions.

Alarms are typically setpoint-driven and can be programmed to monitor certain behaviors, events or unwanted conditions in your electrical system.

You can configure your meter to generate and display high, medium and low priority alarms when predefined events are detected in the meter's measured values or operating states. Your meter also logs the alarm event information.

The meter ships with some alarms already enabled from the factory. Other alarms need to be configured before the meter can generate alarms.

You can customize the meter alarms as required, such as changing the priority. You can also create custom alarms using the advanced features of your meter.

Alarm types

Your meter has five types of alarms.

Type	Description
Setpoint (standard)	Setpoint alarms compare the actual value of a parameter to a specified limit or range of values. These include measured voltage and current values and calculated power quality values. Some setpoint alarms use high-speed measurements for up to 1 millisecond resolution.
Digital	Digital alarms are triggered on a digital input's on/off state.
Disturbance (sag/swell)	Disturbance alarms are triggered on a measured sag or swell.
Transient	Transient alarms are triggered on a measured transient event.
Unary	Unary alarms are not configurable and generate an alarm based on the meter's state, for example, the meter powering up.

Alarms have two states:

- Active: the meter detects the alarm condition is met.
- Historical: the alarm condition previously existed but the condition has since returned to a non-alarm state.

See the *ION Reference*, available from www.schneider-electric.com, for more information about Setpoint, Relative Setpoint, Digital Input, Disturbance Analyzer, Transient and Sag/Swell modules.

Related Topics

- Alarm icon

Standard and high-speed alarms

Alarm speed is determined by the update rate of the framework for the particular alarm.

Standard alarm

Standard alarms have a detection rate of once every 1 second.

High-speed alarm

High-speed alarms have a detection rate of once every half-cycle.

3-phase alarms

Alarms on 3-phase systems are evaluated per phase and reported for each phase.

Some alarms, such as the sag/swell alarm, are evaluated per phase, but reported as a single alarm: Each of the three phases are evaluated for the setpoint condition individually, but there is only one alarm generated. The alarm pickup occurs when the first phase exceeds the alarm pickup magnitude for the pickup time delay. The alarm is active as long as any phase remains in an alarm state. The alarm dropout occurs when the last phase drops below the dropout magnitude for the dropout time delay.

Example of over and under setpoint (standard) alarm operation

The meter supports over and under setpoint conditions on standard alarms.

A setpoint condition occurs when the magnitude of the signal being monitored crosses the limit specified by the pickup setpoint setting and stays within that limit for a minimum time period specified by the pickup time delay setting.

The setpoint condition ends when the magnitude of the signal being monitored crosses the limit specified by dropout setpoint setting and stays within that limit for a minimum time period specified by dropout time delay setting.

Over setpoint

When the value rises above the pickup setpoint setting and remains there long enough to satisfy the pickup time delay period ($\Delta T1$), the alarm condition is set to ON. When the value falls below the dropout setpoint setting and remains there long enough to satisfy the dropout time delay period ($\Delta T2$), the alarm condition is set to OFF.

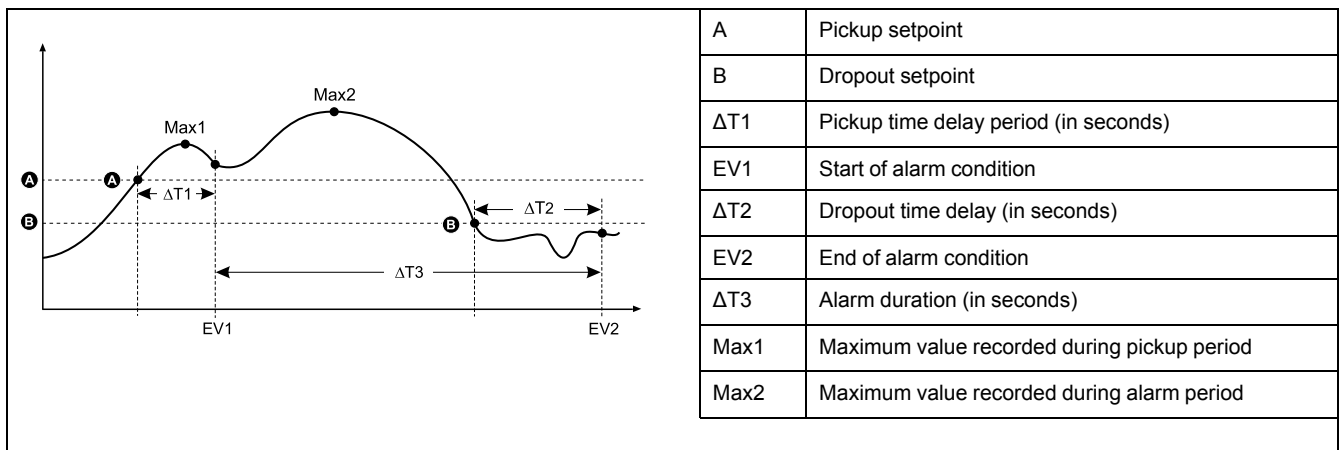

The meter records the date and time when the alarm event starts (EV1) and when it ends (EV2). The meter also performs any task assigned to the event, such as operating a digital output. The meter also records maximum values (Max1, Max2) before, during or after the alarm period.

Under setpoint

When the value falls below the pickup setpoint setting and remains there long enough to satisfy the pickup time delay period ($\Delta T1$), the alarm condition is set to ON. When the value rises above the dropout setpoint setting and remains there long enough to satisfy the dropout time delay period ($\Delta T2$), the alarm condition is set to OFF.

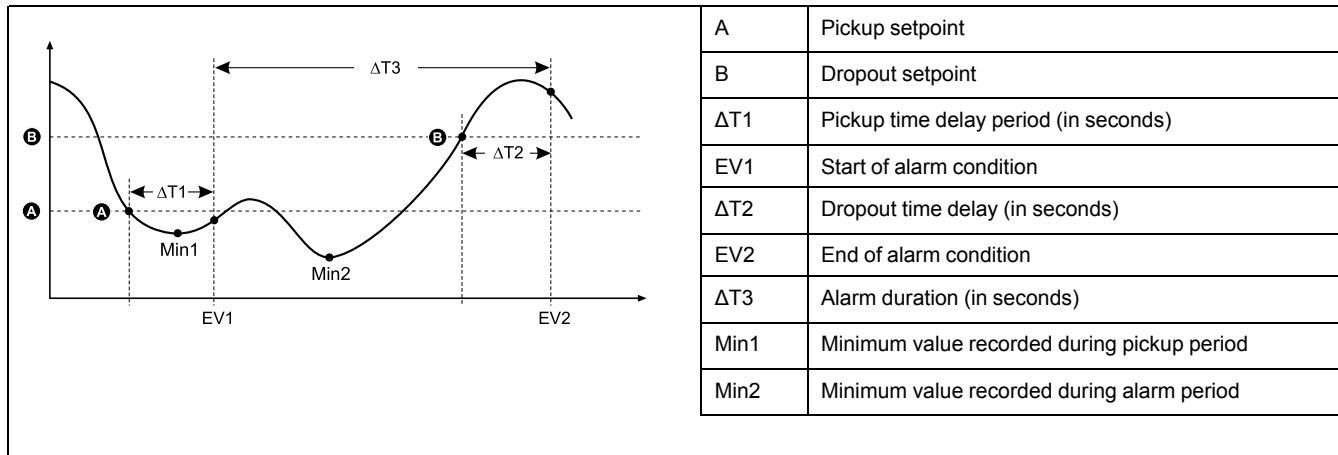

The meter records the date and time when the alarm event starts (EV1) and when it ends (EV2). The meter also performs any task assigned to the event, such as operating a digital output. The meter also records minimum values (Min1, Min2) before, during or after the alarm period.

Relative setpoint

The meter's Relative Setpoint modules behave similarly to the Setpoint modules, except the pickup and dropout levels are set relative to the *Nominal* input source.

For more information on Relative Setpoint modules, download *ION Reference* at www.schneider-electric.com.

Sag/swell alarms

Your meter monitors your power system's voltage and current for sags and swells (INCITS (CBEMA) Type 2 and Type 3 disturbances); it then reports the disturbance's magnitude and duration.

You must configure nominal voltage and current for these alarms to function.

You can manually enter the limits (criteria) used by the meter to identify a sag or swell, or you can have your meter learn sag/swell limits by monitoring your power system.

For more information on the Sag/Swell and Disturbance Analyzer modules, download *ION Reference* at www.schneider-electric.com.

Related Topics

- Configuring Sag/Swell logging using ION Setup

Digital alarms

These alarms are triggered when the associated digital input changes state.

You can configure the alarm to be active when the digital input is on or off, depending on the alarm's purpose.

For example, if you used a digital input to monitor a breaker that is always supposed to be on, you would set the alarm to be active when the breaker has tripped.

NOTE: To stop a digital alarm from being displayed, set the alarm priority to **Info Only**. Disabling the digital alarm (setting it to Force Off) will disable all alarming functions of the associated digital input.

See the *ION Reference*, available from www.schneider-electric.com, for more information about the Digital Input module.

Related Topics

- Configuring digital input alarms using ION Setup
- Configuring onboard digital inputs using ION Setup

Transient alarms

These alarms are triggered by voltage transient activity (i.e., ITI CBEMA Type 1 disturbances).

You must configure nominal voltage for these alarms to function.

The *Threshold* setup register in the Transient module defines what voltage disturbance magnitude should be considered as transient activity. Threshold is interpreted as a percentage of the nominal system voltage, plus 100. For example, if you want transients recorded when voltage deviates from nominal by 20%, enter 120 into the *Threshold* setup register.

For more information on the Transient module, download the *ION Reference* at www.schneider-electric.com.

Related Topics

- Transient overview

Alarm event priorities

Your meter's alarm priorities correspond to event priority ranges.

Alarm priority	Event priority
High (red)	192 - 255
Medium (yellow)	128 - 191
Low (blue)	64 - 127
Info Only (no alarm) ¹	1 - 63
None (no alarm or event) ¹	0

¹ Alarms with priority of Info Only or None are not indicated or displayed.

Info Only and None event priority

Alarms with a priority of **Info Only** or **None** are not shown on the meter's display, and do not function as alarms. If the alarm's priority is set to **Info Only**, and the event priority is greater than the event log cutoff value, the associated event is recorded in the meter's event log. If the alarm's priority is set to **None**, the event priority is automatically set to zero, and no associated event is logged in the meter's event log.

For events that you want to log for future reference or troubleshooting, but don't want alarm functions, set the alarm priority to **Info Only**.

For nuisance events that frequently occur and you have no desire to log for reference or troubleshooting, set the alarm priority to **None**.

Related Topics

- Event log overview

Alarm indicators

Your meter's display has an alarm indicator to show you what alarm levels have been detected (active or historic) and whether they have been acknowledged.

For active high priority alarms, the meter's display will also flash until the alarm is acknowledged. There is also an alarm LED to indicate the meter's alarm condition.

Alarm	Alarm icon	Alarm icon flash	Alarm LED	Meter display
Active high	Red solid bell	Flash if not acknowledged	<ul style="list-style-type: none"> Flash if not acknowledged Steady if acknowledged 	Flash if not acknowledged
Active medium	Yellow solid bell	Flash if not acknowledged	<ul style="list-style-type: none"> Flash if not acknowledged Steady if acknowledged 	No flash
Active low	Blue solid bell	Flash if not acknowledged	<ul style="list-style-type: none"> Flash if not acknowledged Steady if acknowledged 	No flash
Historic high	Red outline bell	Flash if not acknowledged	<ul style="list-style-type: none"> Flash if not acknowledged Steady if acknowledged 	No flash
Historic medium	Yellow outline bell	Flash if not acknowledged	<ul style="list-style-type: none"> Flash if not acknowledged Steady if acknowledged 	No flash
Historic low	Gray solid bell	No flash	Off	No flash
No active or unacknowledged alarms	Gray solid bell	No flash	Off	No flash

If there are multiple active alarms, the meter displays the alarm condition associated with the most important active alarm. If there are multiple unacknowledged historic alarms, the meter displays the alarm condition associated with the most important unacknowledged historic alarm.

NOTE: To stop an alarm from being displayed without impacting other metering features, set the alarm priority to **Info Only**.

Default alarms

Your meter comes with default alarms. Some alarms are enabled by default.

NOTE: Some alarms require configuration in order to operate.

Name	Priority	Description	Default
Current Sag Ph1 - 3	High	Current sag alarms for phase 1, 2, 3	Disabled
Current Swell Ph1 - 3	High	Current swell alarms for phase 1, 2, 3	Disabled
Sag/Swell	High	Voltage sag/swell alarm	Disabled
Over I unbal	Medium	Over unbalanced current alarm	Disabled
Over V unbal	Medium	Over unbalanced voltage alarm	Disabled
Over THD V1 - 3	Medium	Over total harmonic distortion (THD) voltage alarms	Enabled
Over kW (P) sd	Medium	Over kW sliding demand alarm	Disabled
Over I a - c, (1 -3) 4	Medium	Over current alarms	Disabled
V1 - V3 Setpoint	Medium	Voltage setpoint alarms	Disabled
Freq Setpoint	Medium	Frequency setpoint alarm	Enabled
4-30 Volt Intrp Ph1 - 3	Low	4-30 voltage interruption power quality alarms	Enabled

Name	Priority	Description	Default
Transient/Waveshape	High	Transient alarm	Disabled
Digital In	Info Only	Digital input alarms Number of alarms determined by the total number of available digital inputs NOTE: Info Only alarms are not displayed.	Enabled

Alarm information

You can view information about an alarm from your meter's display.

Only alarms with a priority of low, medium or high are displayed.

Parameter	Description
Alarm	The name of the alarm (for example, Over THD V1).
Priority	Low, medium or high alarm priority.
Date	The date and time the alarm was triggered.
Duration	The duration of the alarm (only applies to inactive alarms).
Ack	The date and time when the alarm was acknowledged (only applies to acknowledged alarms).
Value	Active alarm: The minimum or maximum value detected when the alarm was triggered. Historic alarm: The minimum or maximum value detected during the duration of the alarm.

Viewing and acknowledging alarms using the display

You can view and acknowledge alarms using your meter's display

1. Press the **Home** button on the display.
2. Navigate to **Alarms > Active Alarms** or **Historical Alarms**.
3. Press Select.
4. Press the up or down icons to navigate alarms. A gray bar appears behind the active selection.

NOTE: You can press Info to display alarm details.

5. To acknowledge alarms:
 - Press Acknowledge All, or
 - Press the up and down icons simultaneously.

Alarm configuration

Alarm setup using the display

You can enable and disable alarms through the display.

⚠ WARNING**INACCURATE DATA RESULTS**

- Do not use data displayed on the display or in software as a substitute for proper workplace practices or equipment maintenance.
- Confirm your alarm is properly configured.

Failure to follow these instructions can result in death, serious injury, or equipment damage.

Default alarms available on the display

Parameter ¹	Description
Over I unbal	Over unbalanced current alarm
Over THD V1	V1 over total harmonic distortion (THD) voltage alarm
Over THD V2	V2 over total harmonic distortion (THD) voltage alarm
Over THD V3	V3 over total harmonic distortion (THD) voltage alarm
Over kW sd	Over kW sliding demand alarm
Over Ia	Ia over current alarm
Over Ib	Ib over current alarm
Over Ic	Ic over current alarm
Over I4	I4 over current alarm
Over V unbal	Over unbalanced voltage alarm
V1 Setpoint	V1 setpoint alarm
V2 Setpoint	V2 setpoint alarm
V3 Setpoint	V3 setpoint alarm
Freq Setpoint	Frequency setpoint alarm
Sag/Swell 1	Voltage sag/swell alarm
Current Sag Ph1 ²	Current sag alarms for phase 1
Current Sag Ph2 ²	Current sag alarms for phase 2
Current Sag Ph3 ²	Current sag alarms for phase 3
4-30 Volt Intrp Ph1	4-30 voltage interruption power quality alarm for phase 1
4-30 Volt Intrp Ph2	4-30 voltage interruption power quality alarm for phase 2
4-30 Volt Intrp Ph3	4-30 voltage interruption power quality alarm for phase 3
Current Swell Ph1 ²	Current swell alarms for phase 1
Current Swell Ph2 ²	Current swell alarms for phase 2
Current Swell Ph3 ²	Current swell alarms for phase 3

¹ Any Setpoint or Relative Setpoint module with an event priority greater than or equal to the Low alarm event priority is also displayed on this screen.

² Enabling or disabling one phase for each alarm type will enable or disable all phases for that type.

You can only enable or disable alarms using the display. Alarm configuration is done using ION Setup. Alarms with a priority less than **Low (Info Only or None)** are not displayed.

You must configure all the parameters related to the alarm for alarm functions to operate. For example, for the Over Ia alarm to operate, you must enter the nominal value and the conditions that define an alarm state, even if the alarm is shown as Enabled on the Alarm Setup screen.

Disabling and enabling alarms using the display

You can disable alarms using the meter's display when you are performing maintenance tasks on your system and want to prevent nuisance alarms.

NOTE: To stop an alarm from being displayed without impacting other metering features, set the alarm priority to **Info Only**.

1. Press the **Home** button on the display.
2. Navigate to **Setup Menu > Alarm Setup**.
3. Press Select.
4. Press Edit. Enter your meter's password, if prompted.
5. Press the up or down icons to navigate alarms. A gray bar appears behind the active selection.
6. To select the item(s):
 - Press Select for Enable/Disable, or
 - Press the up and down icons simultaneously.
7. Press Select to accept the change.
8. Press Select to confirm.
9. Complete the system maintenance tasks.
10. Enable the alarms you disabled.

Related Topics

- Meter setup using your display

Configuring setpoint/standard alarms using ION Setup

You can use ION Setup to configure the standard alarm settings.

1. Start ION Setup.
2. Open the Setup Assistant for your meter.
3. Navigate to **Alarming** and click the **Standard** tab.
4. Select a setpoint and click **Edit**.
5. Enter the password and click **OK**, if required.

The **Setpoint Setup** screen is displayed.
6. Configure the setpoint values as required.

7. Click **Save** to save the settings to your meter.

Parameter	Value/Range	Description
By Percentage	By Percentage/By Value	When available, specifies if the Pickup and Dropoff entries are by percentage or by value. If the option is not available, pickup and dropoff entries are by value.
Force Off	Checked/Unchecked	Forcing the alarm off disables all functions of the associated input. To stop an alarm from being displayed without affecting other meter features, set the alarm priority to Info Only.
Label	String value	When available, lets you modify the default label so it more clearly identifies the alarm. Letters, numbers, and underscores are permitted.
Pickup	Numeric value	Use this setting to provide a value for when the alarm turns on.
Pickup Delay	Numeric value	This specifies the number of seconds the input must be over the alarm pickup value before the alarm turns on.
Dropout	Numeric value	Use this setting to provide a value for when the alarm turns off.
Dropout Delay	Numeric value	This specifies the number of seconds the input must be below the alarm dropoff value before the alarm turns off.
Alarm Priority	None, Info Only, Low, Medium or High	Specifies the priority level of the standard alarm. When priority is set to Info Only, the alarm does not appear on the display.
Custom Priority	0-255	Select custom priority to view and configure the event priority of the event associated with the alarm. The event log cutoff value is displayed for reference; priorities above the cutoff are stored in the meter's event log.

Sag/swell overview

Your meter monitors your power system's voltage and current for sags and swells (INCITS (CBEMA) Type 2 and Type 3 disturbances); it then reports the disturbance's magnitude and duration.

You can manually enter the limits (criteria) used by the meter to identify a sag or swell, or you can have your meter learn sag/swell limits by monitoring your power system.

Related Topics

- Sag/swell alarms
- Configuring Sag/Swell logging using ION Setup
- Setpoint learning overview
- Waveform recording overview

Configuring sag/swell alarms using ION Setup

You can use ION Setup to configure the sag/swell alarm settings.

1. Start ION Setup.
2. Open the Setup Assistant for your meter.
3. Navigate to **Alarming > Sag/Swell**.
4. Select the parameter you want to configure and click **Edit**.

The setup dialog box for that parameter appears.

5. Configure the parameters as required.

The values you need to set vary depending on the type of sag/swell alarm you are configuring.

Voltage sag/swell setup parameters

Parameter	Value/Range	Description
Enable/Disable	Enabled or Disabled	Specifies if sag/swell recording and alarming is enabled.
Nominal	1 to 999,999	Specifies the nominal voltage value used for sag/swell detection.
Swell Limit	Percentage of nominal	Specifies the swell limit expressed as a percentage of the nominal voltage.
Sag Limit	Percentage of nominal	Specifies the sag limit expressed as a percentage of the nominal voltage.
Hysteresis	Percentage – see description	Specifies the difference in magnitude between the sag or swell limit and the threshold for the power quality event to be considered over. For example, if the meter has the sag limit set to 90% of nominal and the hysteresis is set to 2%, this means that in a sag event, the voltage needs to return to 92% of nominal for the sag event to be considered over
Alarm priority	See description	Select the alarm priority you want to associate with Sag/Swell alarms. To stop an alarm from being displayed without affecting other meter features, set the alarm priority to Info Only.

Current sag/swell setup parameters

Parameter	Value/Range	Description
Enable/Disable	Enabled or Disabled	Specifies if sag/swell recording and alarming is enabled.
Nominal	1 to 999,999	Specifies the nominal current value used for current sag or current swell detection.
Pickup	Percentage of nominal	Specifies the percentage the current must deviate from the nominal current in order to be classified as a sag or a swell.
Dropout	Percentage of nominal	Specifies the percentage of nominal the current must recover to in order to signal the end of the sag or the swell.
Hysteresis	N/A	Displays the difference in magnitude between the sag or swell Pickup and Dropout values. To change the hysteresis, change the Pickup or Dropout values.
Alarm priority	See description	Select the alarm priority you want to associate with Sag/Swell alarms. To stop an alarm from being displayed without affecting other meter features, set the alarm priority to Info Only.

Related Topics

- Configuring Advanced PQ using ION Setup
- Configuring Sag/Swell logging using ION Setup
- Implementing sag/swell limit learning using ION Setup

Configuring transient alarms using ION Setup

You can use ION Setup to configure the transient alarm settings.

1. Start ION Setup.
2. Open the Setup Assistant for your meter.
3. Navigate to **Alarming > Transient**.
4. Select **Transient/Waveshape** and click **Edit**.

The setup dialog box for that parameter appears.

5. Configure the parameters as required.

Transient setup parameters

Parameter	Value/Range	Description
Enabled/Disabled	Enabled or Disabled	Specifies if transient recording and alarming is enabled.
Nominal	1 to 999,999	Specifies the nominal voltage value used for transient detection.
Threshold	Percentage of nominal	Specifies the threshold expressed as a percentage of the nominal voltage, plus 100. For example, if you want transients recorded when voltage deviates from nominal by 20%, enter 120.
Alarm priority	See description	Select the alarm priority you want to associate with Transient alarms. To stop an alarm from being displayed without affecting other meter features, set the alarm priority to Info Only.

Configuring digital input alarms using ION Setup

You can use ION Setup to configure the digital alarm settings.

1. Start ION Setup.
2. Open the Setup Assistant for your meter.
3. Navigate to **Alarming > Digital Input**.
4. Configure the digital input alarm settings by selecting an input and clicking **Edit**. Some settings are not configurable and are grayed out.
5. Click **Save** to save the changes to the meter.

Parameter	Value/Range	Description
Input	Input On/Input Off	Specifies the input state/alarm behavior: <ul style="list-style-type: none"> • Input On: the alarm is on when the digital input is on. • Input Off: the alarm is on when the digital input is off.
Force Off	Checked/Unchecked	Forcing the alarm off disables all functions of the associated input. To stop an alarm from being displayed without affecting digital input features, set the alarm priority to Info Only.
Label	String value	When available, lets you modify the default label so it more clearly identifies the alarm. Letters, numbers, and underscores are permitted.
Alarm Priority	None, Info Only, Low, Medium or High	Specifies the priority level of the digital input alarm. To disable the alarm, set priority to Info Only.
Custom Priority	0-255	Select custom priority to view and configure the event priority of the event associated with the alarm. The event log cutoff value is displayed for reference; event priorities above the cutoff are stored in the meter's event log.

Alerting

An alert is an external notification from the meter to indicate changes, for example, a change of state for a digital input, or a power quality event such as a sag or swell.

When an alert condition occurs, a pulse or trigger is sent and generates the alert. You can configure alerts to send notification emails or messages to your energy management system through your meter's existing Ethernet communications connections. You can configure alert messages as a simple text string or you can also include device information. You can configure the alert's priority so that alerts are also recorded in the meter's event log.

You can configure multiple alerts on a single meter, each having different activation triggers, messages and/or transmission types. For instance, you can have two alerts, one generating an email, the other sending a message to your energy management system, but using the same trigger conditions; or you can have two

alerts with different conditions that send two unique emails to two different email addresses. You can also generate alerts based on triggers from devices connected to your meter.

Creating alerts is an advanced feature that requires familiarity with ION architecture and your power system and communications network. To create an alert, you must configure the Alert module using a configuration tool. You must also configure your device's communications as needed to send the alerts, such as configuring your meter's SMTP settings and connecting it via Ethernet to an SMTP mail server in order to send an alert by email.

Go to www.schneider-electric.com to see the *ION meter alerts* technical note for detailed information on creating and configuring alerts, and the *ION Reference* for detailed information about the Alert module and its operation.

Setpoint learning overview

Your meter can learn acceptable ranges or thresholds by monitoring normal operating values to determine what constitutes a voltage sag, swell or transient in order to help identify high and low setpoints.

NOTE: To help your meter learn the most accurate values possible, it is important that learning occur during a period of normal operation. Do not schedule learning during a period of unusual operations in your system. Do not modify your meter's configuration during the learning period as it may stop the learning process.

You can configure the meter so that learned values are applied automatically once the learning period is complete or require that they are reviewed and manually applied. If a learned value is invalid, the learned values are not automatically applied, but logged for review.

Setpoint learning can be used to identify the following values:

Feature	Values
Setpoints (Alarms)	High limit Low limit Sustain until ON Sustain until OFF
Sag	Voltage sag limit
Swell	Voltage swell limit
Transient	Threshold

Learning installation mode and learning duration

You can configure learning for manual or automatic mode.

There are two learning installation modes:

- **Manual:** the meter learns the applicable values but does not begin using the learned values. The learned values are recorded for review, and you can decide to use the learned values or adjust them as required before manually implementing the learned values.
- **Automatic:** the meter learns the applicable values and begins using those learned values automatically at the end of the learning period. If a learned value is invalid, the meter does not apply the value, but the value is recorded in the event log.

You can configure the maximum learning duration. The actual learning duration may vary, depending on the stability of the system. If the system is stable for a period equal to one quarter of the maximum learning duration, learning is complete; otherwise, the learning period will be the maximum learning duration.

Example: Setpoint learning duration in a stable system

In this example, the learning duration is 30 days. When the system is stable for 7.5 days (one quarter of 30 days) learning is complete.

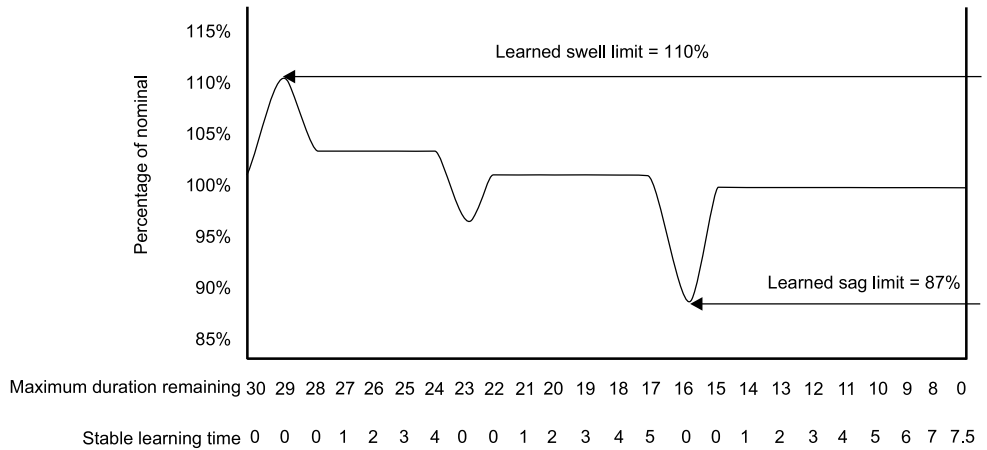

Example: Setpoint learning duration in an unstable system

In this example, the learning duration is 30 days. Because the system is not stable for 7.5 days (one quarter of the 30 days) learning is complete at the end of the maximum learning duration.

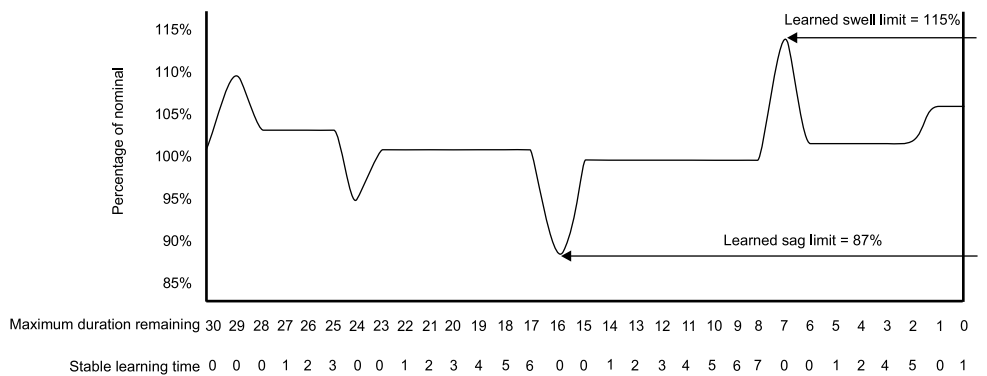

See the ION Reference, available from www.schneider-electric.com, for more information on Sag/Swell, Setpoint and Relative Setpoint modules.

Implementing standard alarm setpoint learning using ION Setup

You can use ION Setup to implement setpoint learning, which analyzes your power system and recommends settings.

NOTE: Your meter’s power system must be stable in order to learn valid setpoint values.

1. Start ION Setup.
2. Open the Setup Assistant for your meter.
3. Navigate to **Alarming > Standard**.

NOTE: You can manually configure setpoint values by selecting the setpoint and clicking **Edit**.

4. Select a setpoint and click **Learn**.

The **Global Setpoint Learning** screen is displayed.

5. Select the setpoint tabs to view existing configured or learned setpoint information.

6. Click **Setup**.

The **Alarm Learning Setup** screen is displayed.

Setpoint learning parameters

Parameter	Value/Range	Description
Install mode	Automatic, Manual	<ul style="list-style-type: none"> Automatic: the learned values are automatically applied. Manual: the learned values are stored for you to review and enter.
Duration	1-365	Days for maximum learning duration.

7. Configure the learning parameters for each setpoint and click **Save**.8. Click **Start All** to begin setpoint learning for all setpoints. Click **Yes** to confirm or **No** to cancel.

- Learning status and time remaining are indicated in the Learning Status box.
- Click **Abort** to stop learning for a specific setpoint. To stop all setpoint learning, repeat for each setpoint tab.

9. Apply the learned setpoint values:

- Automatic: the setpoint values are automatically applied unless the learning process has issues or the learned values are invalid.
- Manual: navigate to **Alarming > Setpoints** and click **Learn**. On each setpoint tab, click **Install** to apply the learned values to that setpoint.

NOTE: If you click **Install** while learning is in progress (in either manual or automatic installation mode), it stops the learning process and prompts you for confirmation that you want to stop learning and install the learned values. Once you confirm, the learned values are automatically installed or prepared for manual installation.

Implementing sag/swell limit learning using ION Setup

You can use ION Setup to implement voltage sag/swell learning, which analyzes your power system and recommends settings.

NOTE: Your meter's power system must be stable in order to learn valid sag/swell limits.

1. Start ION Setup.
2. Open the Setup Assistant for your meter.
3. Navigate to **Alarming > Sag/Swell**.
4. Select **Voltage** and click **Learn**.

NOTE: Learning is not supported for **Current Swell** and **Current Sag**.

NOTE: You can manually configure the limit values by selecting the parameter and clicking **Edit**.

The **Global Setpoint Learning** screen is displayed.

5. Click **Setup**.

The **Alarm Learning Setup** screen is displayed.

Sag/swell limit learning parameters

Parameter	Value/Range	Description
Install mode	Automatic, Manual	<ul style="list-style-type: none"> Automatic: the learned values are automatically applied. Manual: the learned values are stored for you to review and enter.
Duration	1-365	Days for maximum learning duration.

6. Configure the sag/swell limit learning parameters and click **Save**.7. Click **Start** to begin sag/swell limit learning.

- Learning status and time remaining are indicated in the Learning Status box.
- Click **Abort** to stop sag/swell limit learning.

8. Apply the learned sag/swell limits.

- Automatic: the limits are automatically applied unless there are issues with the learning process.
- Manual: navigate to **Alarming > Sag/Swell**. Select **Voltage** and click **Learn**. Click **Install** to apply the learned limits.

NOTE: If you click **Install** while learning is in progress (in either manual or automatic installation mode), it stops the learning process and prompts you for confirmation that you want to stop learning and install the learned limits. Once you have confirmed, the learned limits are automatically installed or prepared for manual installation.

Implementing transient learning using ION Setup

You can use ION Setup to implement voltage transient learning, which analyzes your power system and recommends settings.

NOTE: Your meter's power system must be stable in order to learn valid transient thresholds.

1. Start ION Setup.
2. Open the Setup Assistant for your meter.
3. Navigate to **Alarming > Transient**.
4. Select **Transient/Waveshape** and click **Learn**.

The **Global Setpoint Learning** screen is displayed.

5. Click **Setup**.

The **Alarm Learning Setup** screen is displayed.

6. Configure the transient threshold learning parameters and click **Save**.7. Click **Start** to begin transient learning.

- Learning status and time remaining are indicated in the Learning Status box.
- Click **Abort** to stop transient learning.

8. Apply the learned values.

- Automatic: the threshold is automatically applied unless there are issues with the learning process.
- Manual: navigate to **Alarming > Transient**. Select **Transient/Waveshape** and click **Learn**. Click **Install** to apply the learned values.

NOTE: If you click **Install** while learning is in progress (in either manual or automatic installation mode), it stops the learning process and prompts you for confirmation that you want to stop learning and install the learned limits. Once you have confirmed, the learned values are automatically installed or prepared for manual installation.

Transient learning parameters

Parameter	Value/Range	Description
Install mode	Automatic, Manual	<ul style="list-style-type: none">• Automatic: the learned values are automatically applied.• Manual: the learned values are stored for you to review and enter.
Duration	1-365	Days for maximum learning duration.

Power quality

Power quality overview

Your meter measures voltage and current harmonics, and calculates several harmonic distortion values, including K-factor and crest factor.

Configure your meter with the power system's nominal values for voltage, current and frequency in order for the meter to perform power quality calculations.

Considerations for power quality configuration using ION Setup

Use ION Setup to configure sag/swell, transient and advanced power quality logging.

NOTE: For waveform recording to trigger automatically, enter your system's nominal (normal) voltage and current values and the amount of deviation from the nominal that is considered a sag or a swell using the **Metering > Basic or Alarming** screen

NOTE: Changing your meter's data logging (including burst data logging) and waveform recording configuration clears your meter's existing data logs, waveform records and COMTRADE waveform files.

Before setting up the PQ parameters, make sure the meter has been configured correctly:

- metering parameters such as volts mode and PT/CT ratios
- time sync settings, for integrating the meter in an energy management system such as Power Monitoring Expert
- nominal system parameters (nominal volts, nominal current and nominal frequency), for detecting power quality events
- amount of deviation from the nominal that is considered a sag or swell

Make sure you understand:

- the structure of the meter's logging framework
- the meter's existing logging configuration
- your data logging requirements

Changing the meter's data recorder and waveform recorder configuration clears existing data and waveforms in those recorders.

NOTICE

DATA LOSS

Ensure that all important data and waveforms have been recorded before configuring the data and waveform recorders.

Failure to follow these instructions can result in data loss.

Related Topics

- Configure basic metering parameters
- Configuring sag/swell alarms using ION Setup
- Logging overview

Power quality logging

Sag/swell overview

Your meter monitors your power system's voltage and current for sags and swells (INCITS (CBEMA) Type 2 and Type 3 disturbances).

When sag/swell limits are defined and alarming is enabled, the meter reports the disturbance's magnitude and duration, and logs data and waveform records associated with the disturbance.

Related Topics

- Burst data logging

Configuring Sag/Swell logging using ION Setup

Use ION Setup to configure your meter to log data and waveform records related to sag/swell events, and to export the waveform data to COMTRADE files.

NOTE: There are 2 data recorders for logging sag/swell related data: Sag/Swell Log (Data Recorder #5) records data for plotting the ITI(CBEMA) curve, and Sg/Sw HS Log (Data Recorder #6) records voltage and current data from the High-Speed Power Meter module.

To set up the Sag/Swell Log, Sag/Swell Burst Log, Sag/Swell Waveform Log and Sag/Swell COMTRADE files:

1. Start ION Setup.
2. Open the Setup Assistant for your meter.
3. Navigate to **Power Quality > Sag/Swell Logging**.
4. Select the data log and click **Edit**. Enter the meter password if prompted. The **Sag/Swell Logging Wizard** appears.
5. The **Device setting verification** screen displays results of the meter configuration check for potential errors related to sag/swell monitoring and reporting. Click **Fix** to view details, or click **Next** to ignore the results and proceed to the next screen.
6. The **Disturbance Logging Setup** screen displays the **Log Depth** setting for Sag/Swell Log (Data Recorder #5). You can change the maximum number of records to store in this log. Click **Next** to proceed to the next screen.

7. The **High Speed Recording** screen displays the settings for the high-speed Sag/Swell data recorder (Sg/Sw HS Log — Data Recorder #6). You can configure these settings for the meter to perform burst data logging.

Parameter	Description
Enable Burst Data Logging	Select or clear this check box to turn burst data logging on or off.
Pre-trigger recording ¹	Specifies, in seconds, how many pre-event records to capture. The actual number of records set in the high-speed Sag/Swell data recorder's <i>Pre-trigger Records</i> setup register = (2 x system frequency) x (number of seconds).
Post-trigger recording ¹	Specifies, in seconds, how many post-event records to capture. The actual data number of records set in the high-speed Sag/Swell data recorder's <i>Post-trigger Records</i> = (2 x system frequency) x (number of seconds).
Total # of recordings ²	Specifies how many burst data log sets to save in long-term memory (NVRAM). The actual number of records is configured in the high-speed Sag/Swell data recorder's <i>Depth</i> setup register = (Total # of recordings) x (<i>Pre-trigger Records</i> + <i>Post-trigger Records</i> + 1). See "Data recorder burst data", page 154 for an example of how a data log set is calculated.

¹ If system frequency is changed, the recording duration for Pre-trigger recording and Post-trigger recording automatically adjusts to reflect the new frequency setting.

² When burst data logging is enabled, the equivalent number of records for 2 burst data log sets is allocated in short-term memory (RAM). The actual number of records set in the high-speed Sag/Swell data recorder's *Buffer Depth* setup register = 2 x (*Pre-trigger Records* + *Post-trigger Records* + 1).

Click **Next**.

8. The **Waveform Log Setup** screen allows you to configure the waveform recorder for Standard or Delayed waveform capture.

NOTE: The **Sag/Swell Logging Wizard** does not support Extended waveform capture. See "Waveform capture", page 155 for details on Standard, Delayed and Extended waveform capture.

Parameter	Description
Waveform Depth	Specifies the maximum number of waveform records stored on the meter.
Waveform Format	Specifies the number of samples per cycle and the number of cycles that are stored in a waveform record.
Trigger Position	Specifies the number of cycles to capture before the waveform versus after the waveform. Trigger position can be set using the pre-cycle arrows or the slider bar.

NOTE: The maximum number of cycles (pre-event + post-event) cannot exceed the total number of cycles in the waveform format.

Click **Next**.

9. Configure your meter's COMTRADE settings:

- a. Select or clear the **Generate COMTRADE files** check box to enable or disable the creation of COMTRADE records.

NOTE: The waveform viewer on your meter's webpages uses the meter's COMTRADE files. If you want to view waveforms on the meter's webpages, select **Generate COMTRADE files**.

NOTE: The factory-default configuration for COMTRADE only supports Standard waveform capture.

- b. Set the **Log depth** for the COMTRADE files to specify the maximum number of records stored on your meter's FTP site.

10. Click **Finish**.

You are returned to the Sag/Swell Logging screen and the entry shows your new configuration.

If nothing happens when you click **Finish**, check the log depths and buffer depths for all your other data logs to make sure that the meter has enough memory for these changes. Adjust the log depth and buffer depth of the data and waveform recorders if needed.

Related Topics

- Sag/swell alarms
- COMTRADE implementation overview
- Changing log interval and depth settings using ION Setup

Transient overview

Your meter monitors your power system's voltage and detects ITI (CBEMA) type disturbances related to transients.

When voltage transient limits are defined and alarming is enabled, the meter reports the disturbance's magnitude and duration, and logs data and waveform records associated with the disturbance.

Related Topics

- Transient alarms

Configuring Transient logging using ION Setup

Use ION Setup to configure your meter to log data and waveform records related to voltage transient events, and to export the waveform data to COMTRADE files.

NOTE: Transient Log (Data Recorder #15) records voltage transient related data.

To set up the Transient Log, Transient Waveform Log and Transient COMTRADE files:

1. Start ION Setup.
2. Open the Setup Assistant for your meter.
3. Navigate to **Power Quality > Transient Logging**.
4. Select the data log and click **Edit**. Enter the meter password if prompted. The **Transient Logging Wizard** appears.
5. The **Device setting verification** screen displays the results of meter configuration check for potential errors related to transient monitoring and reporting. Click **Fix** to view details, or click **Next** to ignore the results and proceed to the next screen.
6. The **Transient Logging Setup** screen displays Transient data recorder's **Log Depth** setting. You can change the maximum number of records to store in the Transient data log. Click **Next** to proceed to the next screen.

7. The **Waveform Log Setup** screen allows you to configure the waveform recorder for Standard or Delayed waveform capture.

NOTE: The **Transient Logging Wizard** does not support Extended waveform capture. See “*Waveform capture*”, page 155 for details on Standard, Delayed and Extended waveform capture.

Parameter	Description
Waveform Depth	Specifies the maximum number of waveform records stored on the meter.
Waveform Format	Specifies the number of samples per cycle and the number of cycles that are stored in a waveform record.
Trigger Position	Specifies the number of cycles to capture before the waveform versus after the waveform. Trigger position can be set using the pre-cycle arrows or the slider bar.

NOTE: The maximum number of cycles (pre-event + post-event) cannot exceed the total number of cycles in the waveform format.

Click **Next**.

8. Configure your meter’s COMTRADE settings:
 - a. Select or clear the **Generate COMTRADE files** check box to enable or disable the creation of COMTRADE records.

NOTE: The waveform viewer on your meter’s webpages uses the meter’s COMTRADE files. If you want to view waveforms on the meter’s webpages, select **Generate COMTRADE files**.

NOTE: The factory-default configuration for COMTRADE only supports Standard waveform capture.

- b. Set the **Log depth** for the COMTRADE files to specify the maximum number of records stored on your meter’s FTP site.

9. Click **Finish**.

You are returned to the Transient Logging screen and the entry shows your new configuration.

If nothing happens when you click **Finish**, check the log depths and buffer depths for all your other data logs to make sure that the meter has enough memory for these changes. Adjust the log depth and buffer depth of the data and waveform recorders if needed.

Configuring Advanced PQ using ION Setup

Use ION Setup to configure your meter’s power quality (PQ) monitoring and logging settings for IEC 61000-4-30, EN 50160, IEEE 519 and Rapid Voltage Change (RVC).

The meter’s PQ frameworks are designed with logical dependencies. IEC 61000-4-30 must be enabled first if you want to monitor and record PQ parameters for EN 50160 or IEEE 519. In addition, the Sag/Swell feature must be enabled in order to monitor and detect disturbances such as RVC.

NOTICE
<p>DATA LOSS</p> <ul style="list-style-type: none"> Enable IEC 61000-4-30 before enabling other power quality monitoring and recording features. Enable Sag/Swell before configuring power quality disturbance related features. <p>Failure to follow these instructions can result in data loss.</p>

1. Start ION Setup.

2. Open the Setup Assistant for your meter.
3. Navigate to **Power Quality > Advanced PQ Logging**.
4. Select **4-30 Enable** and click **Edit** to configure your meter's IEC 61000-4-30 logging parameters.
5. Configure the settings as required:

IEC 61000-4-30 Setup

Parameter	Description
Enabled	Select if you want to enable IEC 61000-4-30 monitoring. NOTE: This option must be enabled when monitoring EN 50160 or IEE 519 parameters.
Threshold	Specifies the percentage of nominal voltage that defines a disturbance. For example, if you set this to 10% of 120 V nominal, the disturbance occurs when the voltage dips to 12 V and below.
Hysteresis	Specifies the percentage above the Threshold that defines the end of the disturbance. For example, if you set this to 2%, the end of the disturbance occurs when the voltage rises to (10% + 2%) of nominal, or 14.4 V and above.
Log 4-30 3s measurements	Select if you want to enable IEC 61000-4-30 3-second interval data logging.
Log 4-30 10s measurements	Select if you want to enable IEC 61000-4-30 10-second interval data logging.

6. Click **Send** to save your changes.
The **Advanced PQ Logging** screen shows the new configuration.
7. Select **EN 50160 enable**.
If you want to delete all logged EN 50160 data, click **Reset**, then click **Yes** to confirm.
8. Click **Edit** to configure your meter's EN 50160 logging parameters.
NOTE: You must enable IEC 61000-4-30 before the meter can start monitoring EN 50160 parameters.
9. Configure the settings as required:

EN50160 Configuration Setup

Parameter	Description
Enabled	Select if you want to enable EN 50160 monitoring.
Nominal Voltage	Specifies the nominal voltage value used for EN 50160.
Nominal Frequency	Specifies the nominal frequency used for EN 50160.
Log EN50160 measurements	Select if you want to log EN 50160 parameters. Note that you need to enable EN 50160 monitoring in order to log the parameters.

10. Click **Send** to save your changes.
The **Advanced PQ Logging** screen shows the new configuration.
11. Select **519 enable** and click **Edit** to configure your meter's IEEE 519 logging parameters.
NOTE: You must enable IEC 61000-4-30 before the meter can start monitoring IEEE 519 parameters.

- Configure the settings as required:

IEEE 519 Configuration

Parameter	Description
Nominal Voltage	Displays the nominal voltage value used for IEEE 519. NOTE: If you change the Nominal Voltage, you must return to this setup screen and manually update the IEEE 519 configuration.
<Bus voltage options>	Select the bus voltage at the point of common coupling. Select Disabled if you do not want to log IEEE 519 related data.

- After specifying the bus voltage, click **Next** to configure the IEEE 519 current parameters.

IEEE 519 Configuration

Parameter	Description
Maximum short circuit current	Enter the maximum short-circuit current at the point of common coupling.
Maximum demand load current	Enter the maximum demand load current at the point of common coupling.
Ratio	This displays the maximum short-circuit to maximum demand load ratio. This is used to determine the voltage and current distortion limits.

- Click **Next** to view the screen that displays the voltage and current distortion limits for the harmonic content. Harmonics 2 to 50 and THD/TDD are displayed, with the corresponding set limits for Voltage Distortion % and Current Distortion %.

- Click **Finish** to save your changes.

The **Advanced PQ Logging** screen shows the new configuration.

- Select **RVC enable** and click **Edit** to configure your meter’s RVC (Rapid Voltage Change) feature.

NOTE: You must enable the Sag/Swell module before the meter can start monitoring and detecting RVC.

- Configure the settings as required:

Rapid Voltage Change Setup

Parameter	Description
Enabled	<ul style="list-style-type: none"> Disabled means ION Setup has detected that the Sag/Swell module is disabled. Go to Alarming > Sag/Swell and enable Sag/Swell first, in order for the meter to detect RVC. Yes means RVC monitoring is on. Make sure the Sag/Swell module is enabled, otherwise RVC will not be detected. No means RVC monitoring is off.
Threshold	Specifies, as a percentage, the RMS voltage limit that must be exceeded for an RVC event to occur.
Hysteresis	Specifies, as a percentage, the difference in magnitude between the start and end thresholds for an RVC event.

- Click **Send** to save your changes.

The **Advanced PQ Logging** screen shows the new configuration.

Related Topics

- Configuring sag/swell alarms using ION Setup

Rapid Voltage Change overview

Rapid Voltage Change (RVC) is a quick transition in RMS voltage between two steady-state conditions, during which the voltage does not exceed the sag/swell thresholds.

You can configure the Sag/Swell module to detect and measure RVC and record the event in the meter's Event Log.

For more information on the Sag/Swell module, download the *ION Reference* at www.schneider-electric.com.

Related Topics

- Sag/swell overview
- Configuring sag/swell alarms using ION Setup

Harmonics overview

Harmonics are integer multiples of the fundamental frequency of the power system.

Harmonics information is valuable for power quality analysis, determining properly rated transformers, maintenance and troubleshooting. Evaluation of harmonics is required for compliance to system power quality standards such as EN50160 and meter power quality standards such as IEC 61000-4-30.

Harmonics measurements include per-phase magnitudes and angles (relative to the fundamental frequency of the phase A voltage) for the fundamental and higher order harmonics relative to the fundamental frequency. The meter's power system setting defines which phases are present and determines how line-to-line or line-to-neutral voltage harmonics and current harmonics are calculated.

Harmonics are used to identify whether the supplied system power meets required power quality standards, or if non-linear loads are affecting your power system. Power system harmonics can cause current flow on the neutral conductor, and damage to equipment such as increased heating in electric motors. Power conditioners or harmonic filters can be used to minimize unwanted harmonics.

Viewing harmonics information using the display

You can view detailed harmonics data through the display.

1. Press the Home button on the display.
2. Navigate to **Power Quality > Harmonics**. The total harmonic distortion (THD) screens are displayed.
3. Press More, then use the up or down icons to select the desired harmonics. The per-phase harmonics are graphically displayed.
4. Press the left and right buttons to move to individual harmonics. The harmonic number, magnitude and phase angle are displayed.

Voltage crest factor

Crest factor is the ratio of peak to RMS voltage values.

For a pure sinusoidal waveform, crest factor is equal to 1.414. The meter uses the following equation to calculate crest factor:

$$C = \frac{V_{\text{peak}}}{V_{\text{RMS}}}$$

C = Crest factor

V_{peak} = Voltage peak

V_{RMS} = Voltage RMS

Current crest factor

Crest factor is the ratio of peak to RMS current values.

For a pure sinusoidal waveform, crest factor is equal to 1.414. The meter uses the following equation to calculate crest factor:

$$C = \frac{I_{\text{peak}}}{I_{\text{RMS}}}$$

C = Crest factor

I_{peak} = Current peak

I_{RMS} = Current RMS

K-factor

K-factor relates the heating effect of a distorted current in a transformer to a sinusoidal current with the same RMS magnitude — it describes a transformer's ability to serve non-linear loads without exceeding rated temperature rise limits.

The K-factor is equal to the sum of the squares of the harmonic currents multiplied by the squares of the harmonic order. The meter uses the following equation to calculate K-factor:

$$K = \frac{\sum_{n=1}^h (I_n^2 \times h^2)}{\sum_{n=1}^h I_n^2}$$

Where K is the K-factor, h is the harmonic order and I_h is the true RMS current of harmonic order h .

Harmonic content calculations

Harmonic content (H_C) is equal to the RMS value of all the non-fundamental harmonic components in one phase of the power system.

The meter uses the following equation to calculate H_C :

$$H_C = \sqrt{(H_2)^2 + (H_3)^2 + (H_4)^2 \dots}$$

THD% calculations

THD% is a quick measure of the total distortion present in a waveform and is the ratio of harmonic content (H_C) to the fundamental harmonic (H_1).

By default, the meter uses the following equation to calculate THD%:

$$\text{THD} = \frac{H_C}{H_1} \times 100\%$$

thd and TDD

Your meter can be configured to provide thd (total harmonic distortion using the total RMS value for the content rather than the fundamental content) and TDD (total demand distortion, the harmonic current distortion against the maximum demand of the electrical system).

$$\text{thd} = H_C / \text{RMS} * 100\%$$

$$\text{TDD} = H_C / \text{Demand}_{\text{Max}} * 100\%$$

See the *ION Reference*, available from www.schneider-electric.com, for details about the Harmonics Measurement module.

Phasors

Phasors are used to represent the voltage and current magnitude and angles.

The length of the lines in the phasor diagram represent the relative magnitude of the voltages with respect to the other phase voltages, and the currents with respect to the other phase currents. All angles are measured with respect to the Va/V1 phase. The Va/V1 phasor is fixed to the right-hand horizontal axis (positive x-axis). Positive angles are measured counterclockwise.

Measured values are provided for the magnitude and relative angle for each voltage and current phase.

Delta vector diagrams can be configured to display two different ways:

- Instrument (voltage vectors appear 60 degrees apart - showing the actual voltage and current values that the meter is measuring).
- System (voltage vectors appear 120 degrees apart - showing true system operation including any calculated values).

Phasor information can be used to troubleshoot incorrect connections on the meter's voltage and current inputs (for example, switched phase wiring or polarity errors), if you know how the phasors should be oriented for your power system.

Phasor information can be viewed using ION Setup, the webpages or display.

Power quality standards compliance

Your meter has additional frameworks and settings related to the following power quality standards.

EN 50160

The EN 50160 framework is composed of numerous ION modules including: Mains Signaling Evaluation, Harmonics Evaluation, Voltage Harmonics, Flicker, and more.

Your meter's framework is pre-configured for a low voltage system.

NOTE: Connect your meter to a UPS to avoid losing EN 50160 data in the event of a power outage.

See the *Power quality: ION meters and EN 50160:2010* technical note for details.

IEC 61000-4-30

IEC 61000-4-30 power quality standard compliance is provided by a variety of ION modules including: Power Quality Aggregator, Harmonics Measurement, Disturbance Analyzer, Symmetrical Components, Mains Signaling Evaluation, Sag/Swell and more.

See the *IEC 61000-4-30 compliance and ION meters* technical note for details.

IEC 60255-24 (COMTRADE)

The meter can provide waveforms in **COM**mon format for **TR**ansient **D**ata **E**xchange (COMTRADE) format. COMTRADE records are generated from the existing Waveform Recorder modules that are connected to the COMTRADE module.

See the *COMTRADE and ION Technology* technical note for details.

IEEE 519

The IEEE 519 framework is composed of numerous ION modules including: Harmonics Evaluation, Harmonics Measurement, Counter and more.

Disturbance direction detection overview

Your meter has disturbance direction detection capabilities to help you determine the location of a power system disturbance.

When a disturbance occurs, the meter analyzes the disturbance information to determine the direction of the disturbance relative to the meter. This analysis includes a confidence level indicating the level of certainty that the disturbance is in the determined direction, and is stored in your meter's event log.

Disturbance direction detection is enabled on your meter by default and does not require any additional configuration beyond setting the nominal voltage and nominal frequency.

Disturbance direction detection can help locate the source of a disturbance when used in a system of disturbance direction detection devices. In the diagram below, meters (B), (C) and (D) are installed on the power consumer side, while meter (E) is installed on the utility side.

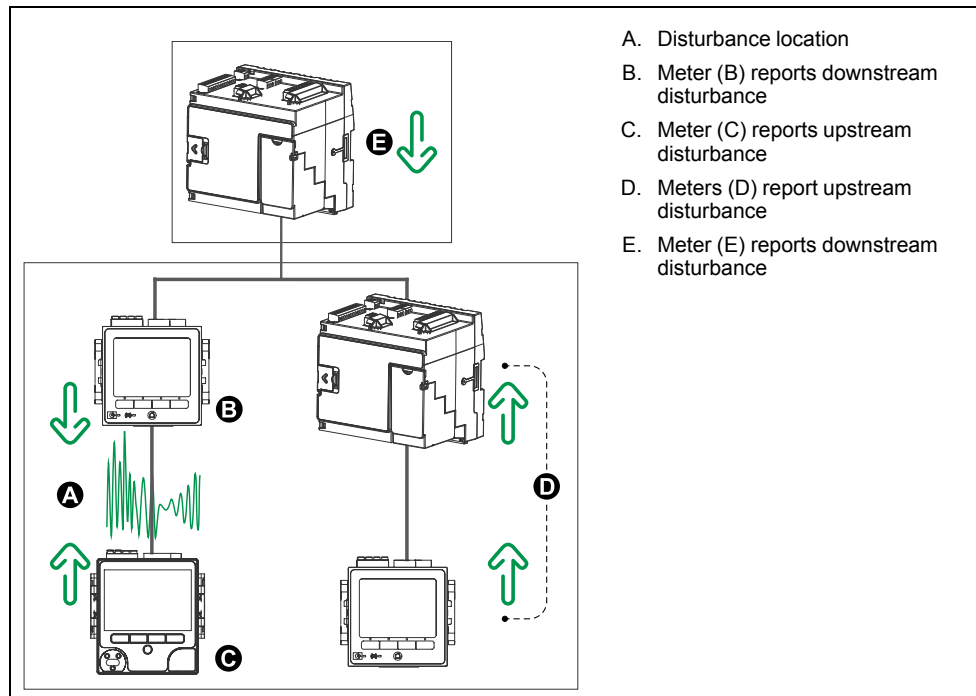

The arrows show the direction the meters have determined for the disturbance. With this information, you can determine that the disturbance occurred between meter (B) and meter (A), and can focus on that section of your system to find the cause of the disturbance.

Disturbance direction detection events

The results of the disturbance direction detection algorithm appear in the meter's event log.

The image below shows an example of how the Disturbance Direction Detection event appears in your meter's event log when viewed using ION Setup.

NOTE: You can view your meter's event log through ION Setup, the meter webpages or display.

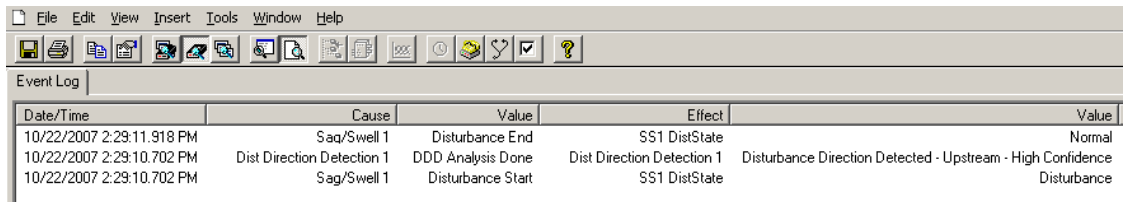

Date/Time	Cause	Value	Effect	Value
10/22/2007 2:29:11.918 PM	Sag/Swell 1	Disturbance End	SS1 DistState	Normal
10/22/2007 2:29:10.702 PM	Dist Direction Detection 1	DDD Analysis Done	Dist Direction Detection 1	Disturbance Direction Detected - Upstream - High Confidence
10/22/2007 2:29:10.702 PM	Sag/Swell 1	Disturbance Start	SS1 DistState	Disturbance

See the *ION Reference*, available from www.schneider-electric.com, for more detailed information about the Disturbance Direction Detection module.

Related Topics

- Event log overview

COMTRADE

Your meter can generate COMTRADE files and store them on the meter's internal FTP site.

COMTRADE stands for COMMon format for TRANsient Data Exchange defined by IEC 60255-24, and defines a common format for power quality event (disturbance) data in order to simplify retrieval, analysis and exchange of disturbance data between multiple sources and vendors.

The format of your meter's COMTRADE files is as defined by IEC 60255-24.

COMTRADE can be used in conjunction with IEC 61850.

See the *COMTRADE and ION technology* technical note, available from www.schneider-electric.com, for detailed information about COMTRADE file formats and implementation.

Related Topics

- FTP

COMTRADE implementation overview

COMTRADE is configured as part of the default waveform recording framework.

COMTRADE records are generated for sag/swell events. Configure your meter nominal voltages to enable waveform recording. COMTRADE records are stored as read-only files on your meter's internal FTP server, and are deleted when you perform a Master reset of the meter, upgrade firmware or make changes to the waveform recorders.

By default:

- The meter is configured so COMTRADE records are generated for the default waveform recorders.

NOTE: If you add additional waveform recorders and you want COMTRADE files generated for these new recorders, you need to configure a new COMTRADE module using ION Setup Advanced mode. You can configure up to three COMTRADE modules.

- The oldest COMTRADE record is overwritten by the newest record when the COMTRADE depth is exceeded.

NOTE: COMTRADE files can only be downloaded using an Ethernet connection. They cannot be downloaded using serial, modem or Ethernet gateway connections.

See the *COMTRADE and ION technology* technical note, available from www.schneider-electric.com, for detailed information about COMTRADE file formats and implementation.

Related Topics

- Configuring Sag/Swell logging using ION Setup
- Viewing waveforms on your meter’s webpages

Waveforms on your meter’s webpages

You can use the waveform viewer on the meter’s webpages to view waveforms generated as a result of power quality events.

Overview of how to setup and view waveforms on your meter’s webpages

Before you can view waveforms on the meter’s webpages, you need to perform some basic configuration to enable waveform capture and store the waveforms in COMTRADE format.

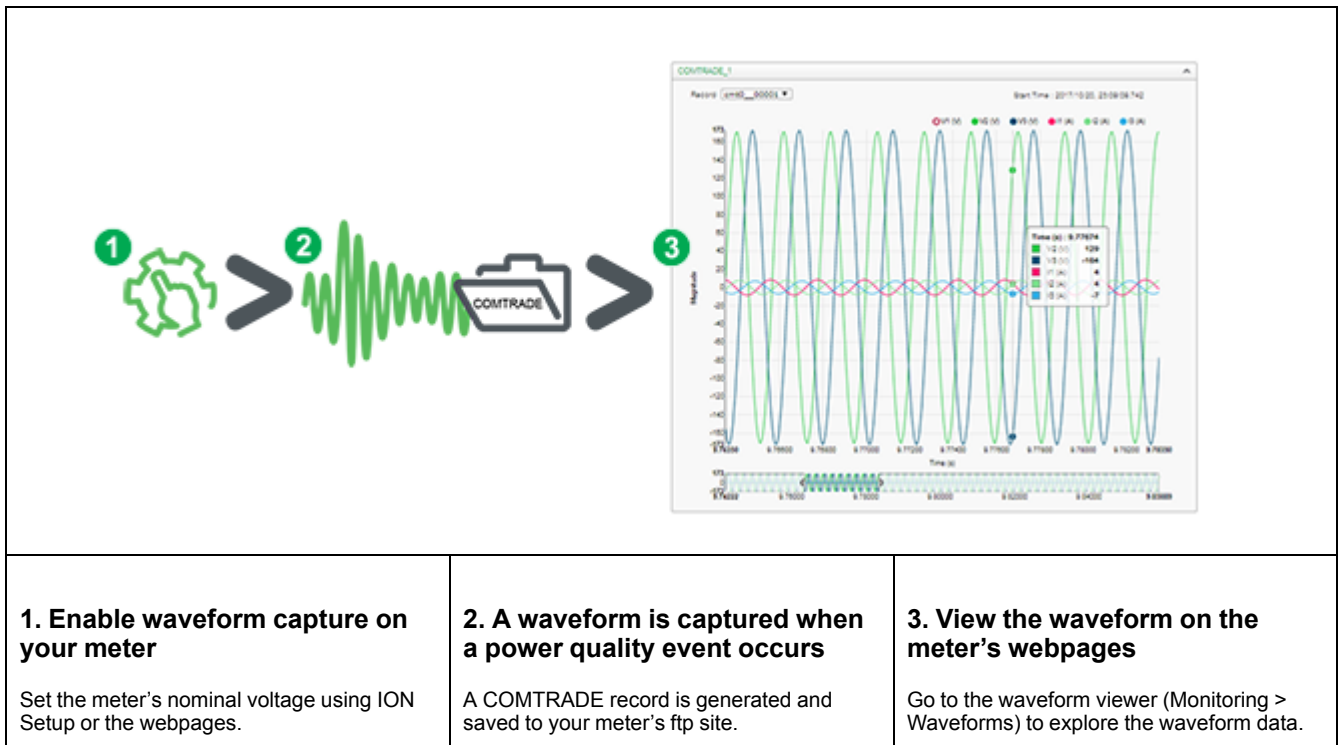

The waveform viewer uses the meter’s COMTRADE files to display the waveforms. If the events you want to capture are not included in the default framework, you can customize the meter’s waveform recording framework.

Overview of the webpage waveform viewer

After COMTRADE files are generated by your meter, you can view them using the waveform viewer.

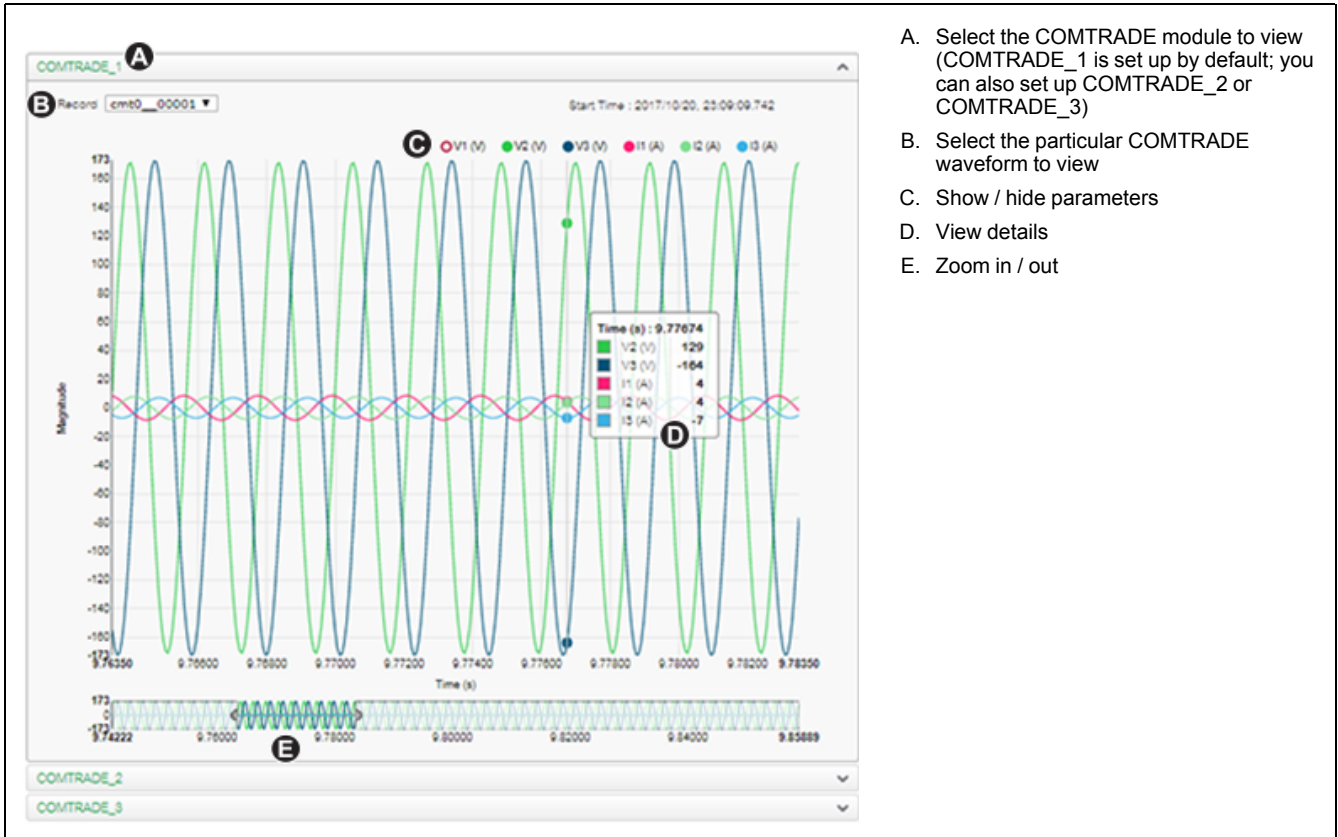

- A. Select the COMTRADE module to view (COMTRADE_1 is set up by default; you can also set up COMTRADE_2 or COMTRADE_3)
- B. Select the particular COMTRADE waveform to view
- C. Show / hide parameters
- D. View details
- E. Zoom in / out

Viewing waveforms on your meter’s webpages

Use the waveform viewer on your meter’s webpages to view the meter’s COMTRADE waveform files.

Before you can view waveforms on your meter’s webpages, you need to make sure your meter is configured to record waveforms by setting the nominal voltage.

1. Launch a browser and go to the IP address for your meter, entering valid login credentials when requested.
2. Navigate to **Monitoring > Waveforms**.

A screen displays with accordion menus for all 3 COMTRADE modules (regardless of whether or not that COMTRADE module is being created by the meter). The waveform viewer for COMTRADE_1 is expanded.

By default, COMTRADE_1 displays the sag/swell waveform records. COMTRADE_2 and COMTRADE_3 are used if you have configured additional waveform recorders and connected them to COMTRADE modules.

3. Select the accordion menu for the COMTRADE records you want to view, for example COMTRADE_2.

The waveform viewer for those COMTRADE records is displayed.

4. Select the file you want to view from the record dropdown.

The numbering starts at 0 (zero), which means you select cmt0_00004 to view the fifth file for COMTRADE_1.

5. Click or tap an individual voltage or current channel in the legend to show or hide it in the waveform viewer.

- ● Visible
- ○ Hidden

- 6. Use the bar at the bottom to zoom in / zoom out on a particular section of the waveform, or to scan through the waveform with the selected zoom level.

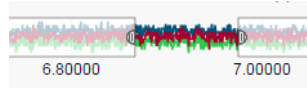

- Draw a window over a particular area to zoom in on that section of the waveform.
 - Drag the selected area to move the zoom across the waveform.
 - Drag the start and end points to expand or narrow the zoom.
- 7. Hover over or tap a spot on the waveform to view the values associated with that particular moment in time.

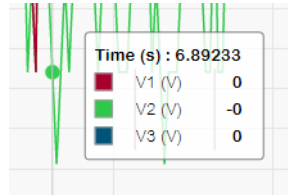

Related Topics

- COMTRADE implementation overview

Burst data logging

Burst data logging is a recording method that captures a snapshot of data that occurred immediately before and immediately after a triggered recording.

Burst data logging is analogous to continuous shooting mode or “burst mode” in photography. An understanding of pre and post event data assists in the analysis of undesired power quality events such as sags or swells.

Burst logging is typically used for high-speed RMS (half-cycle) data capture, but the data recorder supports standard speed (1-second) recording as well, depending on the ION modules connected to the inputs of the Data Recorder module.

NOTE: To maximize the performance of your power management system, it is recommended that devices be connected directly to an Ethernet network.

Data recorder burst data

The meter’s Data Recorder modules support burst data logging.

The Data Recorder module’s *Pre-trigger Records* setup register specifies how many pre-event records are saved with each triggered recording. The *Post-trigger Records* setup register specifies how many post-event records are saved with each triggered recording.

Both *Pre-trigger Records* and *Post-trigger Records* are set to zero by default. To configure the data recorder for burst data logging, either or both of these setup registers must be set to a non-zero positive integer value.

The data log set for each triggered recording is equal to the sum of *Pre-trigger Records* + *Post-trigger Records* + 1 (where 1 is the actual record when the Data Recorder module’s *Record* input was triggered).

For example, if *Pre-trigger Records* is set to 10 and *Post-trigger Records* is set to 5, the number of records for each data log set would be 16:

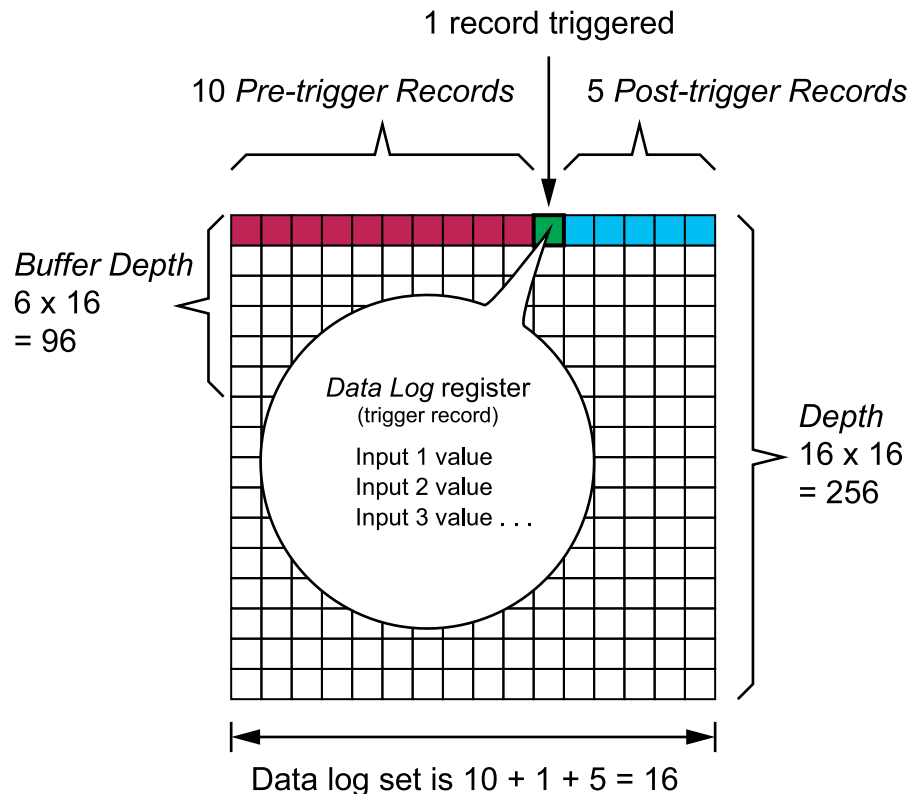

Burst data log set = [pre-trigger records] + [post-trigger records] + [actual trigger record] = 10 + 5 + 1 = 16.

When burst data logging is enabled, both *Buffer Depth* and *Depth* setup registers must be set to a positive integer multiple of the data log set.

Use the system frequency to calculate the number of records needed to capture 1 second of data:

- For 60 Hz, total number of records per second = 60 cycles/second x 2 half-cycles = 120
- For 50 Hz, total number of records per second = 50 cycles/second x 2 half-cycles = 100

You can use the **Power Quality** setup assistant in ION Setup to specify how many seconds of pre-trigger and post-trigger data you want to capture. ION Setup automatically calculates the required number of records based on your input.

Waveform capture

The meter's Waveform Recorder modules capture waveform data.

The Waveform Recorder module captures one waveform record every time its *Record* input is triggered. A waveform record is defined by the module's *Format* setup register, expressed as (number of samples per cycle) x (number of cycles per waveform record). For example, if *Format* is set to 512x4, that means one waveform record is made up of 4 cycles of waveform data at 512 samples per cycle resolution.

Standard waveform capture

The meter's Waveform Recorder modules support standard waveform capture.

A standard waveform capture saves 1 buffered waveform record at the *Record* trigger time. Only pre-trigger waveform data is captured in this mode. No post-trigger waveform cycles are recorded.

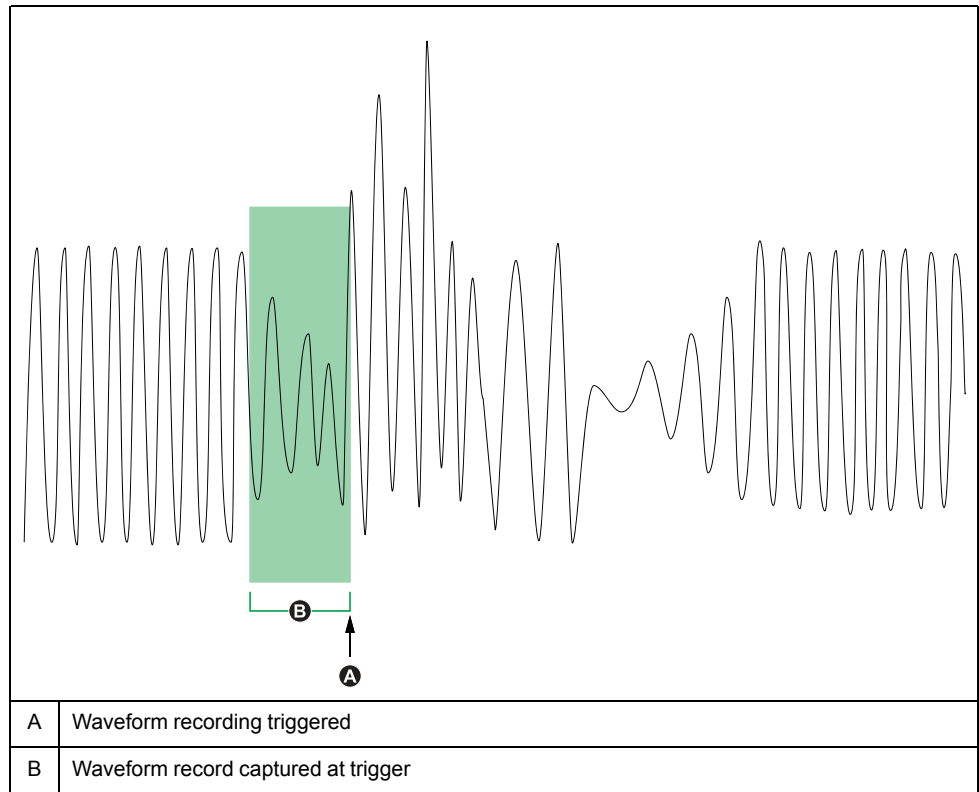

Delayed waveform capture

The meter’s Waveform Recorder modules support delayed waveform capture.

The Waveform Recorder module’s *Record Delay Cycles* setup register specifies how many cycles to delay the waveform capture after the *Record* input is triggered. This is for capturing post-trigger waveform data.

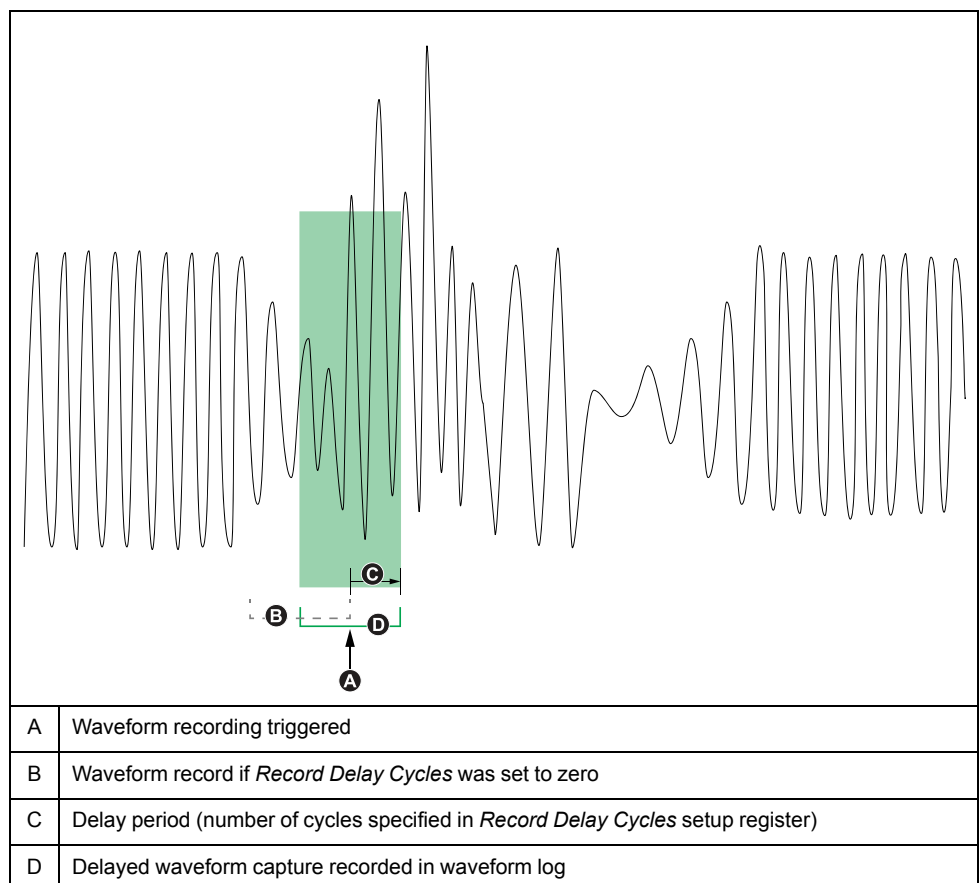

Extended waveform capture

The meter's Waveform Recorder modules support extended waveform capture.

The Waveform Recorder module's *Pre-trigger Records* setup register specifies how many pre-event records are saved with each triggered recording. The *Post-trigger Records* setup register specifies how many post-event records are saved with each triggered recording.

Both *Pre-trigger Records* and *Post-trigger Records* are set to zero by default. To configure the waveform recorder for extended waveform capture, either or both of these setup registers must be set to a non-zero positive integer value. If you do this, you must also set the *Record Delay Cycles* setup register to zero in order to properly configure the extended waveform capture.

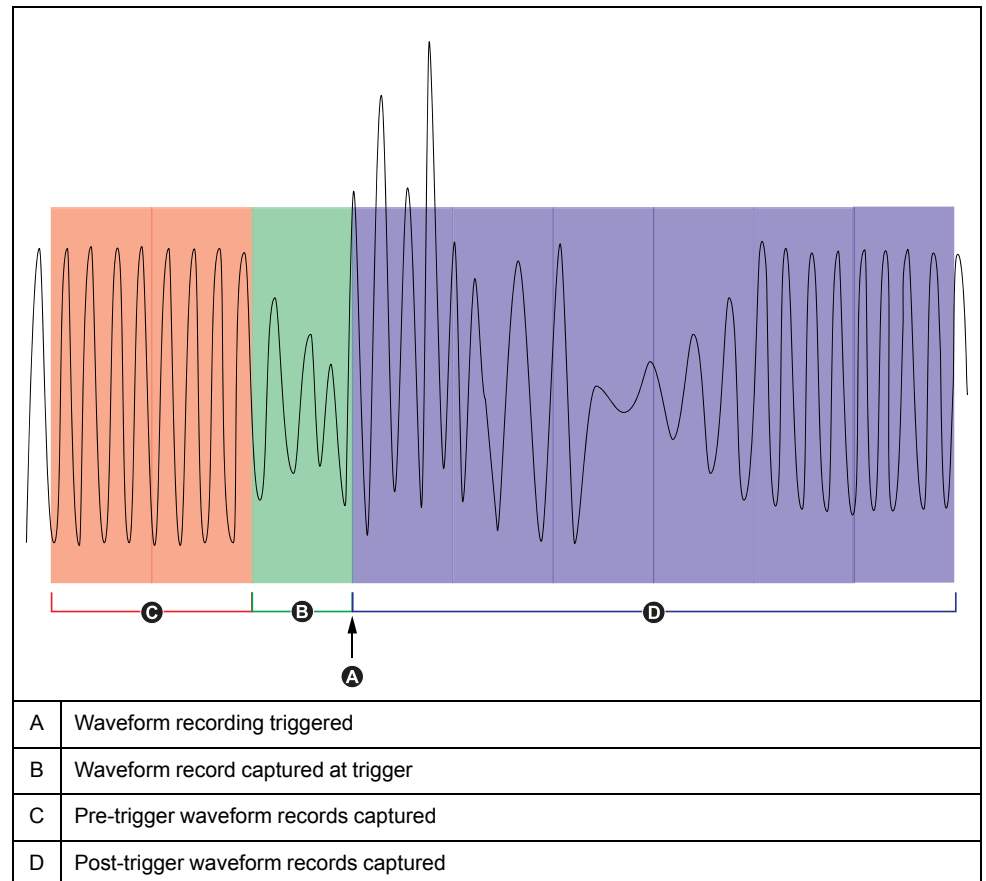

The waveform log set for each triggered recording is equal to the sum of *Pre-trigger Records* + *Post-trigger Records* + 1 (where 1 is the actual record when the Waveform Recorder module's *Record* input was triggered).

For example, if *Pre-trigger Records* is set to 2 and *Post-trigger Records* is set to 6, the number of records for each waveform log set is 9:

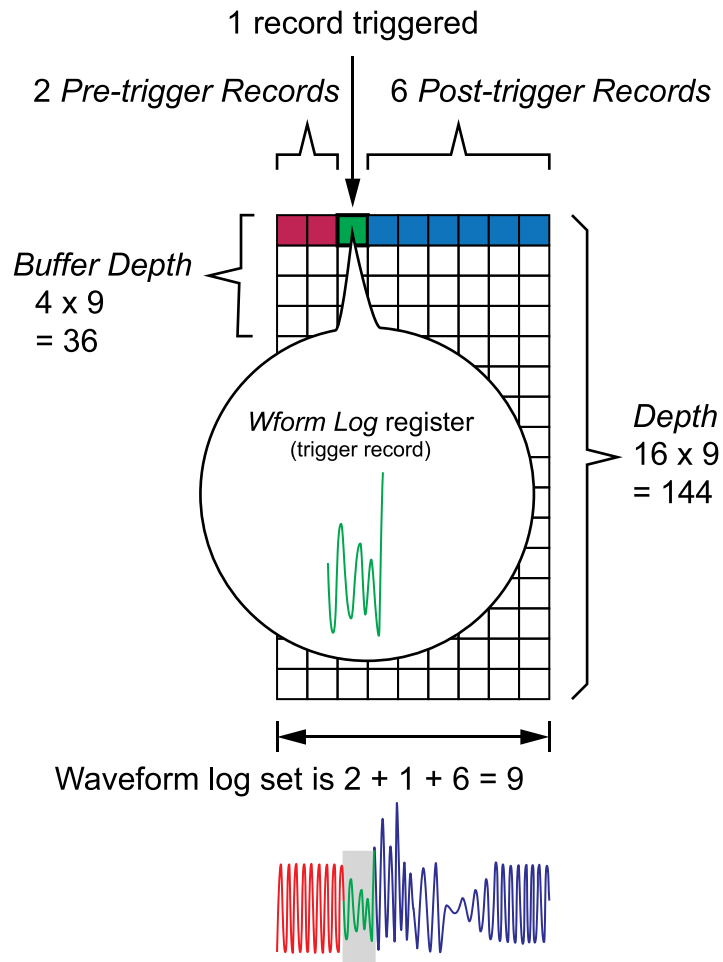

The waveform log set for the extended waveform capture = [pre-trigger records] + [actual trigger record] + [post-trigger records]. The total waveform records captured in this example is 2 + 1 + 6 = 9.

When extended waveform capture is enabled, both *Buffer Depth* and *Depth* setup registers must be set to a positive integer multiple of the waveform log set.

NOTE: The COMTRADE module does not support extended waveform capture. The COMTRADE files saved are only for the trigger waveform record.

Logging

Logging overview

The meter's logging frameworks include factory-configured data recorders, waveform recorders and event logs.

The logging frameworks store data related to:

- Power quality and compliance
- Energy and demand
- Revenue metering
- Trending and forecasting
- Meter events

When your system's nominal parameters are programmed into the meter, power quality events such as sags, swells and transients are automatically detected, and associated voltage and current data and waveforms are logged. Meter data is stored in non-volatile memory, so data is retained even if the meter loses power. If your system nominal values fluctuate, you can configure the meter's setpoint learning feature to learn your power system's normal operating values, then use that information to help identify voltage sags and swells.

The meter's logging framework also supports burst data logging for sag/swell events. When burst data logging is enabled, additional data records immediately before and immediately after the sag/swell event are captured. Energy management systems can then retrieve this information for use in applications such as power event analysis.

NOTE: To maximize the performance of your power management system, it is recommended that devices be connected directly to an Ethernet network.

You can also configure the meter to email data from the logging frameworks. Download the *Internal email client feature* technical note at www.schneider-electric.com for instructions on how to configure your meter to email logged data.

Meter events are recorded in the meter's onboard event log. You can also configure the meter to record events to an external SysLog (systems log) server.

Default data logging configuration

The meter's default framework includes factory-configured data logs (data recorders).

These data logs and their configuration are used by other components of your power monitoring system. Do not change the default configuration of any of the logs unless you understand the impact of the change on these power monitoring system components, the data they use and your meter's memory.

The meter can support up to 100 data logs (data recorders), which can each record up to 16 different parameters.

Revenue log

The Revenue Log (Data Rec 1) is configured for use with UTS MV-90 billing software. Factory settings for this data recorder:

- Log depth = 3360 records (35 days)
- Interval = 900 seconds (15 minutes)

By default, it logs the following values:

Parameter	Description
kWh del int	Interval kWh delivered
kWh rec int	Interval kWh received
kVARh del int	Interval kVARh delivered
kVARh rec int	Interval kVARh received

Historic data logs

Three historic data logs are used to record standard power system quantities, such as phase current, phase voltage and power factor. These logs are labeled Hist Mean Log, Hist High Log, and Hist Low Log. Factory settings for these data recorders:

- Log depth = 3360 records (35 days)
- Interval = 900 seconds (15 minutes)

By default, they log the following values:

Hist Mean Log (Data Rec 2)			
Vll ab mean	V unbal mean	I avg mean	kVA tot mean
Vll bc mean	Ia mean	I 4 mean	PF lag mean
Vll ca mean	Ib mean	kW tot mean	PF lead mean
Vll avg mean	Ic mean	kVAR tot mean	Freq mean

Hist High Log (Data Rec 3)			
Vll ab high	V unbal high	I avg high	kVA tot high
Vll bc high	Ia high	I 4 high	PF lag high
Vll ca high	Ib high	kW tot high	PF lead high
Vll avg high	Ic high	kVAR tot high	Freq high

Hist Low Log (Data Rec 4)			
Vll ab low	V unbal low	I avg low	kVA tot low
Vll bc low	Ia low	I 4 low	PF lag low
Vll ca low	Ib low	kW tot low	PF lead low
Vll avg low	Ic low	kVAR tot low	Freq low

Loss log

The Loss Log (Data Rec 9) is configured to record loss values. Factory settings for this data recorder:

- Log depth = 3360 records (35 days)
- Interval = 900 seconds (15 minutes)

By default, it logs the following values:

Parameter	Description
MU Ia ² h int	Phase A interval current squared hours
MU Ib ² h int	Phase B interval current squared hours
MU Ic ² h int	Phase C interval current squared hours
MU Vllab ² h int	Phase A interval voltage Line-to-Line squared hours
MU Vllbc ² h int	Phase B interval voltage Line-to-Line squared hours
MU Vllca ² h int	Phase C interval voltage Line-to-Line squared hours

Parameter	Description
MU VIn a^2h int	Phase A interval voltage Line-to-Neutral squared hours
MU VIn b^2h int	Phase B interval voltage Line-to-Neutral squared hours
MU VIn c^2h int	Phase C interval voltage Line-to-Neutral squared hours

Harmonics logs

Two harmonics logs record various harmonics data, including K-factor and Total Harmonic Distortion (THD). These recorders are labeled Harm Mean Log and Harm High Log. Factory settings for these data recorders:

- Log depth = 840 records (35 days)
- Interval = 3600 seconds (1 hour)

By default, they log the following values:

Harm Mean Log (Data Rec 7)		
V1 THD mean	I1 THD mean	I1 K Fac mean
V2 THD mean	I2 THD mean	I2 K Fac mean
V3 THD mean	I3 THD mean	I3 K Fac mean

Harm High Log (Data Rec 8)		
V1 THD high	I1 THD high	I1 K Fac high
V2 THD high	I2 THD high	I2 K Fac high
V3 THD high	I3 THD high	I3 K Fac high

Energy and demand log

The EgyDmd Log (Data Rec 10) records energy and demand data used by energy management software to generate reports. Factory settings for this data recorder:

- Log depth = 3360 records (35 days)
- Interval = 900 seconds (15 minutes)

By default, it logs the following values:

Parameter	Description
kWh del	Active energy delivered
kWh rec	Active energy received
kWh del-rec	Active energy delivered minus received
kVARh del	Reactive energy delivered
kVARh rec	Reactive energy received
kVARh del-rec	Reactive energy delivered minus received
kVAh del+rec	Apparent energy delivered plus received
kW sd del-rec	Active power demand delivered minus received
kVAR sd del-rec	Reactive power demand delivered minus received
kVA sd del+rec	Apparent power demand delivered plus received

Daily nominal log

The DailyNom Log (Data Rec 39) provides information about the meter's nominal settings. Factory settings for this data recorder:

- Log depth = 450 records

- Interval = Triggered on demand

By default, it logs the following values from the Factory module's setup registers:

Parameter	Description
FAC1 Vnominal	Nominal voltage setting
FAC1 NomFreqNum	Expected frequency of operation

Rapid voltage change log

The RVC Log (Data Rec 23) provides details of rapid voltage changes related to sag/swells (power quality events). This data recorder is disabled by default. Factory settings for this data recorder:

- Log depth = 100 records
- Interval = Triggered on demand

If enabled, it logs the following by default:

Delta Umax	Delta Uss	RVC Duration
------------	-----------	--------------

Sag/swell log

The Sag/swell Log (Data Rec 5) provides details of power quality events. Factory settings for this data recorder:

- Log depth = 100 records
- Interval = Triggered on demand

By default, it logs the following values:

SS1 DistDur	SS1 DistV1Min	SS1 DistV1Max	SS1 DistV1Avg
SS1 DistV1Engy	SS1 DistV2Min	SS1 DistV2Max	SS1 DistV2Avg
SS1 DistV2Engy	SS1 DistV3Min	SS1 DistV3Max	SS1 DistV3Avg
SS1 DistV3Engy	SS1 DistNominal	SS1 Swell Lim	SS1 Sag Lim

Sag/swell burst log

The Sag/swell Burst Log (Data Rec 6) captures high-speed (half-cycle) voltage and current data that includes pre-event and post-event records related to the sag/swell event. This data recorder is disabled by default.

If enabled, it logs the following by default:

HS VIn a	HS VII ab	HS I a	HS Freq
HS VIn b	HS VII bc	HS I b	PQA1 Vavg Sliding Ref Voltage
HS VIn c	HS VII ca	HS I c	

Transient log

The Transient Log (Data Rec 15) provides details of power quality events. Factory settings for this data recorder: Factory settings for this data recorder:

- Log depth = 100 records
- Interval = Triggered on demand

By default, it logs the following values:

TR1 TranV1Dur	TR1 TranV3Dur	PM1 PT Prim
TR1 TranV1Max	TR1 TranV3Max	PM1 PT Sec
TR1 TranV2Dur	TR1 TranNominal	PM1 CT Prim
TR1 TranV2Max	TR1 Threshold	PM1 CT Sec

EN 50160 compliance logs

The EN 50160 compliance logs are used to record EN 50160 compliance parameters:

Data recorder	EN50160 component logged
EN50160 Flicker (Data Rec 18)	Flicker
EN50160 Frq/Mg (Data Rec 17)	Power frequency and supply magnitude
EN50160 Hrm Vlt (Data Rec 29)	Voltage harmonics
EN50160 Ihm Vlt (Data Rec 30)	Voltage interharmonics
EN50160 Intrp (Data Rec 24)	Short/log interruptions
EN50160 MSignal (Data Rec 31)	Evaluation of mains voltage signals
EN50160 Prm-f/V (Data Rec 32)	Parameter data (disabled by default)
EN50160 Prm-Flk (Data Rec 33)	Parameter data (disabled by default)
EN50160 PrmHrm1 (Data Rec 12)	Parameter data (disabled by default)
EN50160 PrmHrm2 (Data Rec 11)	Parameter data (disabled by default)
EN50160 Swell (Data Rec 25)	Voltage swells
EN50160 Vlt Dp1 (Data Rec 19)	Supply voltage dips
EN50160 Vlt Dp2 (Data Rec 20)	Supply voltage dips
EN50160 Vunbal (Data Rec 28)	Voltage unbalance

The meter logs EN50160 counter data for present and previous observation periods as well as EN51060 events.

Download the *EN50160 2010 compliance and ION meters* technical note at www.schneider-electric.com for more information about your meter's EN50160 compliance.

IEC 61000-4-30 compliance logs

The IEC 61000-4-30 compliance logs are used to log parameters related to the International Electrotechnical Commission's IEC 61000-4-30 standards' power quality compliance and to create reports:

2hr RMS Log (Data Rec 37) and 10m RMS Log (Data Rec 16)

PqFlag	PQA1 I1	V1 OverDev	V3 OverDev
V1	PQA1 I2	V2 UnderDev	Power Freq
V2	PQA1 I3	V2 OverDev	
V3	V1 UnderDev	V3 UnderDev	

3s RMS Log (Data Rec 38)

PqFlag	I1	V1 OverDev	V3 OverDev
V1	I2	V2 UnderDev	
V2	I3	V2 OverDev	
V3	V1 UnderDev	V3 UnderDev	

2hr THD Log (Data Rec 34) and 4–30 3s THD Log (Data Rec 26)

PqFlag	V3 THD	I3 THD	I unbal u2
V1 THD	I1 THD	Vunbal u2	I unbal u0
V2 THD	I2 THD	Vunbal u0	

10m THD Log (Data Rec 27)

PqFlag	V3 THD	PQ I3 THD	I unbal u2
V1 THD	PQ I1 THD	Vunbal u2	I unbal u0
V2 THD	PQ I2 THD	Vunbal u0	

10s Freq (Data Rec 21)

Power Frequency	PqFlag
-----------------	--------

Intrp (Data Rec 22)

V Intrp DrtnAll (voltage interruption duration - all voltages)
--

Download the *IEC 61000-4-30 Compliance and ION Meters* technical note at www.schneider-electric.com for more information about your meter's IEC 61000-4-30 compliance.

IEEE 519 compliance logs

The IEEE 519 compliance logs are used to record IEEE 519 compliance parameters:

Data recorder	IEEE 519 component logged
519 Hrm I-X (Data Rec 35)	Current harmonics
519 Hrm I-Y (Data Rec 36)	Current harmonics
519 Hrm I-Z (Data Rec 14)	Current harmonics
519 Hrm V-X (Data Rec 42)	Voltage harmonics
519 Hrm V-Z (Data Rec 13)	Voltage harmonics
I1 Hrm 1-16 (Data Rec 44)	I1 current harmonics
I1 Hrm 17-32 (Data Rec 50)	I1 current harmonics
I1 Hrm 33-48 (Data Rec 56)	I1 current harmonics
I2 Hrm 1-16 (Data Rec 45)	I2 current harmonics
I2 Hrm 17-32 (Data Rec 51)	I2 current harmonics
I2 Hrm 33-48 (Data Rec 56)	I2 current harmonics
I3 Hrm 1-16 (Data Rec 46)	I3 current harmonics
I3 Hrm 17-32 (Data Rec 52)	I3 current harmonics
I3 Hrm 33-48 (Data Rec 57)	I3 current harmonics
V/I Hrm 49-50 (Data Rec 59)	V1, V2, V3, I1, I2, I3 harmonics
V1 Hrm 1-16 (Data Rec 40)	V1 voltage harmonics
V1 Hrm 17-32 (Data Rec 47)	V1 voltage harmonics
V1 Hrm 33-48 (Data Rec 53)	V1 voltage harmonics
V2Hrm 1-16 (Data Rec 41)	V2 voltage harmonics
V2Hrm 17-32 (Data Rec 48)	V2 voltage harmonics
V2Hrm 33-48 (Data Rec 54)	V2 voltage harmonics
V3Hrm 1-16 (Data Rec 43)	V3 voltage harmonics

Data recorder	IEEE 519 component logged
V3Hrm 17-32 (Data Rec 49)	V3 voltage harmonics
V3Hrm 33-48 (Data Rec 55)	V3 voltage harmonics

Related Topics

- Configuring data logging using ION Setup

Configuring data logging using ION Setup

Use ION Setup to configure the meter’s data recorders.

Changing the meter’s data recorder configuration clears existing data in that data recorder.

NOTICE
<p>DATA LOSS</p> <p>Ensure that all important data has been recorded before configuring data recording.</p> <p>Failure to follow these instructions can result in data loss.</p>

1. Start ION Setup.
2. Open the Setup Assistant for your meter.
3. Navigate to **Logging > Memory**.
4. In the **Status** tab, select the data log and click **Edit**. The **Log Depth Setup** window appears.
5. Configure the settings as applicable:

Parameter	Description
Log Interval	How frequently records are logged
Log Depth	Maximum number of records stored in the log
Log Memory	Information only. This is automatically calculated, and displays how much memory the log uses based on the Log Interval and Log Depth
Log Storage	Information only. This is automatically calculated, and displays how much total memory is left after subtracting the Log Memory usage

Related Topics

- Default data logging configuration

Waveform recording overview

The meter’s factory-configured waveform recorders store waveform data related to power quality events.

Waveform information is used to help identify power system disturbances, which are an increasing concern for industrial plants, hospitals, data centers and other facilities where the equipment is sensitive to voltage or current sags, swells, transients, and momentary interruptions. Waveform information is also used to help ensure compliance with power quality standards.

In addition to measuring and recording numerical values for voltage and current, your meter can also capture the sinusoidal waveform data. The current and voltage waveform data provides additional information for analysis of the system’s power quality or a power quality event.

When your system's nominal parameters are programmed into the meter, power quality events such as sags, swells and transients are automatically detected and voltage and current waveform data is logged. The default factory settings for sag/swell and transient detection are sufficient for most applications, but you can also modify the amount of deviation from the nominal required to trigger waveform recording.

Waveform data storage format

Your meter's waveform data storage format is defined by:

- Cycles: the number of cycles included in the waveform (its duration).
- Samples: samples per cycle, which is the number of waveform data points collected in each cycle.

This gives you the option to record a lot of information for a very short duration or less information over a longer duration. You can also configure the waveform recording to record pre-event and post-event data.

Types of waveform data

You can use your meter to detect ITI (CBEMA) - type disturbances, and can determine information regarding the magnitude and duration of each disturbance. This information can be used by your energy management system to plot the disturbance on an ITI (CBEMA) curve.

COMTRADE waveform data is available from your meter.

NOTE: If you are generating COMTRADE waveform information, the associated waveform recorders cannot be modified unless COMTRADE is disabled. If the waveform recorders are not configured identically, COMTRADE waveform information will not be generated.

Key terms

Term	Definition
COMTRADE	COMmon format for TRAnsient Data Exchange (COMTRADE) is a common format for waveform data.
ITI (CBEMA)	A curve that graphically describes an AC input voltage envelope which can be typically tolerated by information technology equipment. Meter waveform information is plotted on this curve to help evaluate power quality.
Nominal	The normal or usual parameter value. For example, the nominal voltage for many power systems is 120 V.
Sag	A power event where the voltage or current drops below the nominal value.
Swell	A power event where the voltage or current rises above the nominal value.
Transient	A power event where a short duration surge of electrical energy is detected.

See the ION Reference, available from www.schneider-electric.com, for more information on the Waveform Recorder module and its settings.

Related Topics

- Default waveform recording configuration

Default waveform recording configuration

The meter's default framework includes factory-configured waveform logs (waveform recorders).

These waveform logs and their configuration are used by other components of your power monitoring system. Do not change the default configuration of any of the logs unless you understand the impact of the change on these power monitoring system components, the data they use and your meter's memory.

Waveform Recorder modules

The factory-default Waveform Recorder modules are preconfigured to capture sag/swell and transient power quality events.

Waveform recorder	Description
Wfm Rc V1-Sg/Sw (Wform Rec 1)	V1 voltage waveforms recorded during a defined sag or swell event.
Wfm Rc V2-Sg/Sw (Wform Rec 2)	V2 voltage waveforms recorded during a defined sag or swell event.
Wfm Rc V3-Sg/Sw (Wform Rec 3)	V3 voltage waveforms recorded during a defined sag or swell event.
Wfm Rc I1-Sg/Sw (Wform Rec 5)	I1 current waveforms recorded during a defined sag or swell event.
Wfm Rc I2-Sg/Sw (Wform Rec 6)	I2 current waveforms recorded during a defined sag or swell event.
Wfm Rc I3-Sg/Sw (Wform Rec 7)	I3 current waveforms recorded during a defined sag or swell event.
Vfm Rc V1-Trnst (Wform Rec 9)	V1 voltage waveforms recorded during a defined transient event.
Vfm Rc V2-Trnst (Wform Rec 10)	V2 voltage waveforms recorded during a defined transient event.
Vfm Rc V3-Trnst (Wform Rec 11)	V3 voltage waveforms recorded during a defined transient event.
Vfm Rc I1-Trnst (Wform Rec 13)	I1 current waveforms recorded during a defined transient event.
Vfm Rc I2-Trnst (Wform Rec 14)	I2 current waveforms recorded during a defined transient event.
Vfm Rc I3-Trnst (Wform Rec 15)	I3 current waveforms recorded during a defined transient event.

COMTRADE modules

The factory-default COMTRADE modules are preconfigured with their inputs linked to the *Trigger* outputs of the waveform recorders for sag/swell and transient monitoring.

COMTRADE 1 inputs (sag/swell)	Linked Waveform Recorder (<i>Trigger</i> output)
<i>Waveform Trigger 1</i>	Wfm Rc V1-Sg/Sw (Wform Rec 1)
<i>Waveform Trigger 2</i>	Wfm Rc V2-Sg/Sw (Wform Rec 2)
<i>Waveform Trigger 3</i>	Wfm Rc V3-Sg/Sw (Wform Rec 3)
<i>Waveform Trigger 4</i>	Wfm Rc I1-Sg/Sw (Wform Rec 5)
<i>Waveform Trigger 5</i>	Wfm Rc I2-Sg/Sw (Wform Rec 6)
<i>Waveform Trigger 6</i>	Wfm Rc I3-Sg/Sw (Wform Rec 7)

COMTRADE 2 inputs (transient)	Linked Waveform Recorder (<i>Trigger</i> output)
<i>Waveform Trigger 1</i>	Vfm Rc V1-Trnst (Wform Rec 9)
<i>Waveform Trigger 2</i>	Vfm Rc V2-Trnst (Wform Rec 10)
<i>Waveform Trigger 3</i>	Vfm Rc V3-Trnst (Wform Rec 11)
<i>Waveform Trigger 4</i>	Vfm Rc I1-Trnst (Wform Rec 13)
<i>Waveform Trigger 5</i>	Vfm Rc I2-Trnst (Wform Rec 14)
<i>Waveform Trigger 6</i>	Vfm Rc I3-Trnst (Wform Rec 15)

Related Topics

- Waveform recording overview

Event log overview

Your meter records events produced by the meter’s ION modules or external meter events.

Meter events, such as meter configuration or changes to I/O state, have priority values associated with them, so you can control what events are logged. Each event has a priority based on its type and severity, and for most events you can configure the priority. The event log records the date and time of the event, along with relevant details about the event.

Your meter’s event log can be viewed through the meter’s display and ION Setup.

Event log data example:

Date/Time	Cause	Value	Effect	Value
11/10/2014 11:21:13.577 AM	Ethernet	FTP	Front Panel	Auth FAIL
11/10/2014 11:21:43.000 AM	Front Panel	Remote Display	Front Panel	File received on RMD
11/10/2014 11:24:45.000 AM	Front Panel	Remote Display	Front Panel	RMD firmware upgrade successful
11/10/2014 11:24:48.135 AM	Front Panel	Remote Display	Front Panel	RMD disconnected
11/10/2014 11:25:15.820 AM	Front Panel	Remote Display	Front Panel	RMD connected
11/10/2014 11:29:27.316 AM	Ethernet	FTP	Front Panel	Auth FAIL

NOTE: This example is representative only, and your meter’s event log may appear different than shown.

See the ION Reference, available from www.schneider-electric.com, for more information about the Event Log Controller module and other ION modules.

Default event log configuration

Your meter logs all configuration changes, meter access events, and power system events.

You can configure certain features, such as the digital inputs, so an event is logged when the feature changes state (for example, the digital input changes from off to on).

Your meter’s event log might be used by other components of your power monitoring system. Do not change the default event log configuration unless you understand the impact of the change on the power monitoring system components and the data they use and on your meter’s memory.

Changing the default event log configuration should only be undertaken by those with an advanced understanding of ION architecture and their meter’s template.

The event log is controlled by the Event Log Controller module, which allows you to set a priority cutoff for event logging. Events with a priority number greater than the cutoff value are logged, and events with lower priorities are discarded. By default, this value is set so that all relevant events are recorded in the meter’s event log. Event priority values range from 0 to 255 with a typical cutoff value of 5.

NOTE: Alarms are generated by events from certain ION modules. The alarm level is determined by the priority of the associated event. To disable the alarm but still record the associated event, set the alarm priority to **Info Only**. To disable the alarm and the event, set the alarm priority to **None**.

See the ION Reference, available from www.schneider-electric.com, for more information about the Event Log Controller module and event priorities for specific ION modules.

Related Topics

- Alarms overview

User triggered event log entries

The Event Log includes an association between security-related events and the username that was logged in to the meter during the event.

When a user produces an event, such as a reset, successful or unsuccessful login attempts, user lockout or setup change, it is written to the event log. Events created in standard security through the display or communications have the username USER0. Events created in advanced security through the display or ION Setup are associated with the username that was logged into the meter (USER1 - USER50).

Date/Time	Cause	Value	Effect	Value	User
10/17/2016 4:07:46 022 PM	Ethernet	Changed Setup	SOP1 Enable Advanced Security	Value Changed	USER0
10/18/2016 9:26:26 044 AM	Ethernet	HTTP	Front Panel	Auth FAIL	USER0
10/20/2016 11:06:07 503 AM	Ethernet	Changed Setup	ETH1 Enable Telnet	No	USER1
10/20/2016 11:06:07 520 AM	Ethernet	Changed Setup	ETH1 Telnet Port Number	23	USER1
10/20/2016 11:06:24 042 AM	Ethernet	Changed Setup	ETH1 Enable Telnet	Yes	USER1
10/20/2016 11:06:24 054 AM	Ethernet	Changed Setup	ETH1 Telnet Port Number	23	USER1

Assigning a designated reader for event log notification

A user can be assigned the role of designated reader for the event log.

When the *Designated Reader* is configured, an entry in the event log is considered unread until it has been reviewed or backed up to external storage by the designated reader. When the designated reader is informed that the event log is nearly full, an event log review or backup strategy can be implemented before older entries are overwritten. This feature can assist in ensuring that event log entries are not overwritten before they can be reviewed. Use ION Setup to select a user to be the designated reader.

1. Open advanced configuration mode for your meter. See the ION Setup Help for instructions.
2. Open the EventLogCtl Modules folder and double click **EventLogCtl**.
3. Enter login credentials as necessary.
4. Click the **Setup Registers** tab
5. Select *Designated Reader* and click **Edit**.
6. Set *Designated Reader* to the user that reviews the event log (USER0 - USER50) and click **OK**.

Syslog overview

Syslog uses the User Datagram Protocol (UDP) to transport event log information from the meter directly to a centralized syslog server.

The syslog server can receive logs from multiple devices, including meters, then store and filter the log information as needed. You can use ION Setup to modify the syslog network settings for your device. Syslog is a useful feature to help maintain meter log information for extended periods of time.

NOTE: Ethernet is required to use the syslog feature.

Syslog is an open standard allowing you to use any one of a number of syslog server applications currently available. The decision regarding which syslog server solution to use can be based on budget and your technical requirements. See the individual syslog server's documentation for more information.

Configuring Syslog network settings using ION Setup

You can configure your syslog settings using ION Setup.

1. Open the Setup Assistant for your meter. See the ION Setup Help for instructions.
2. Select **Communications** > **Advanced Ethernet** and click the **SysLog** tab.
3. Select **Enable Syslog** and click **Edit**.
4. Select **Yes** to enable the syslog server feature or select **No** to disable it.
5. Click **OK**.
6. Select **Syslog Server** and click **Edit**.
7. Enter the IPv4 address or an IPv6 address for the syslog server.

You must enter the IP address for the syslog server, not the server's fully-qualified domain name.

8. Click **OK**.
9. Verify that the Syslog server is receiving log information from the meter.

NOTE: If the *Enable Syslog* register is enabled but the *Syslog Server* register does not contain an IP address, an event is generated in the event log to indicate that syslog is enabled with no server IP.

Related Topics

- Syslog

Syslog severity to event log priority mapping

Syslog severities map to ION event priorities (0-255).

Only four of the syslog severities are used in the mapping.

Syslog severity	ION event priority name	ION event priority range
2 - Critical condition	High	192-255
4 - Warning condition	Medium	128-191
5 - Normal but significant condition	Low	64-127
6 - Informational	None	0-63

Advanced log setup and memory optimization

You can configure your meter's logs to help ensure the integrity of critical data and to optimize the meter's memory usage.

Before you configure your meter's logs, it is important to understand how logging functions and how the settings work together.

NOTE: Configuring your meter's logs requires an in-depth understanding of the meter's memory, how the logs function and the data you are capturing.

Viewing log configuration and memory usage information

You can use ION Setup to view log settings and memory usage information for your meter's default logs.

This information can help you understand your log usage and how to optimize your logging configuration for your situation.

1. Start ION Setup.
2. Open the Setup Assistant for your meter.
3. Navigate to the **Logging > Memory** screen.

The **Status** tab:

- lists the default logs, their interval (**Duration**) and depth (**Records**), if applicable, and the percentage of available memory used by the log.
- provides information on how much of the meter's memory is used for system tasks in the System Resources list item.
- displays the total meter memory and the percentage of memory in use versus memory available.

Log depth configuration

You can change the number of records (depth) stored in the log.

Use ION Setup to change the maximum number of records (depth) stored in the log in the meter's long-term memory.

Data logs and circular-format waveform recorders have a minimum depth of 1 record. The maximum depth is dependent on your meter's memory and the configuration of your other logs.

Log interval configuration

You can configure the logging interval, which is how frequently records are logged.

You can change the logging intervals for most logs using the ION Setup Assistant **Logging > Memory** screen.

Changing the interval for other logs (for example, logs that are related to standards or triggered by disturbances) is an advanced procedure that involves using the Advanced mode of ION Setup to modify settings in the module that is linked to the log's *Record* input. See the ION Setup help and the *ION Reference* for more information.

Programming your meter to write to any data recorder at continuous intervals shorter than 60 seconds (heavy logging configuration) can cause loss of data in the event of a power failure.

NOTICE

DATA LOSS

Use an uninterruptible power supply (UPS) if you program your meter for heavy logging.

Failure to follow these instructions can result in data loss.

Log mode configuration

You can configure the log record mode, or how the log behaves when full.

Changing how the log records information (circular or stop-when-full) is an advanced procedure that requires changing the *RecordMode* setup register in the Data Recorder and Waveform Recorder modules.

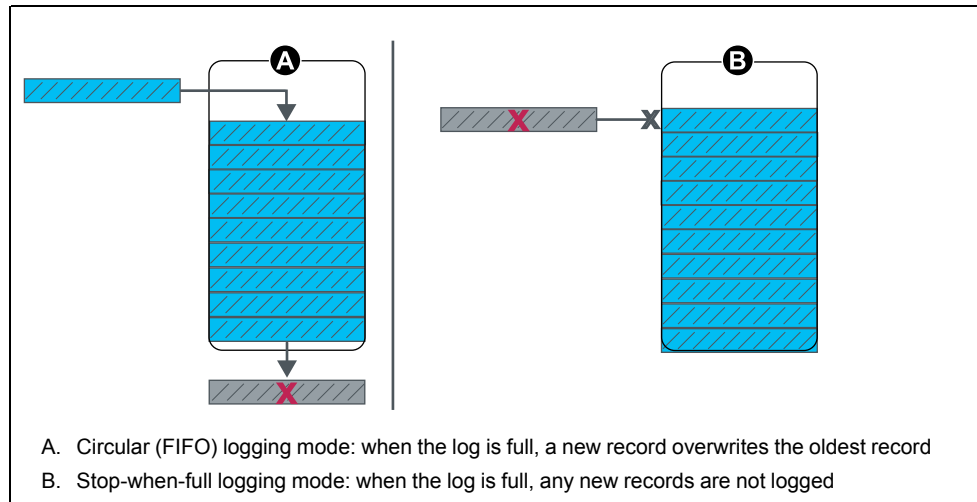

Log buffer configuration

The log buffer depth is the maximum number of records that can be stored in the meter's short-term memory (RAM) for a particular log.

After records are captured in the log buffer in the meter's short-term memory, they are replicated to the long-term memory. Because of inherent differences between short-term (volatile) and long-term (non-volatile) memory, records can be added more quickly to the short-term memory than they can be copied to long-term memory.

The logs in the default logging framework have their log buffer depths pre-configured to a value suitable for most applications. But you can configure the log buffer depth for your applications, if required (for example, to help ensure the continuity of critical data in high-speed logging scenarios or to optimize usage of your meter's memory for your particular logging configuration).

If you are logging data at high speeds, it is important to review your logging needs, and find the right balance between data retention and memory optimization for your particular situation.

NOTE: If you get a message that you do not have sufficient memory when you try to create a new log or change the configuration of an existing log, you may need to reduce the log buffer depths of other logs in order to make memory available for the new log.

Fully buffered logs

A fully buffered log (e.g., a Data Recorder or Waveform Recorder module) is one where the value of the Buffer Depth setup register is the same as the Depth setup register. This means the buffer (short-term memory) is set up to use all the available long-term memory allocated for that log. This ensures the buffer does not run out of space before all the records are replicated to the long-term memory, regardless of the recording speed (i.e., the rate of record captures).

You may want to use this configuration if you are logging critical data (for example, revenue logs) or logging data at frequent intervals (for example, intervals less than 60 seconds). However, it is important to note that this configuration uses the most short-term memory, or RAM (the meter has a maximum 10 MB of RAM available for the log buffer depth).

Partially buffered logs

A partially buffered log (e.g., for a Data Recorder or Waveform Recorder module) is one where the value of the Buffer Depth setup register is less than the Depth setup register. This means the buffer (short-term memory) is set up to use only a portion of the available long-term memory allocated for that log. This configuration allows for a much larger log size (i.e., number of records). However this does not ensure that the buffer does not run out before all the records are replicated to the long-term memory (e.g., in the case of high-speed recording).

You may want to use this configuration for logs with intervals greater than 60 seconds or with less critical data. Because the records are partially replicated, this configuration uses less of the meter’s short-term memory, or RAM, in a log that is otherwise configured the same. This allows you to make more RAM available for other logs with a higher logging frequency or more critical data.

However, depending on your configuration, there may be instances where the log buffer fills up faster than it can replicate records to long-term memory. In this case, you may lose records and see gaps in your data.

NOTE: The *Insert Outage Records* functionality does not work if the data recorder is configured as partially buffered. In order to use this functionality, you must configure the data recorder to be fully buffered. See the Data Recorder module description in the *ION Reference*, available for download from www.schneider-electric.com, for more information on *Insert Outage Records* functionality.

Example: fully buffered log records replicated from short-term to long-term memory

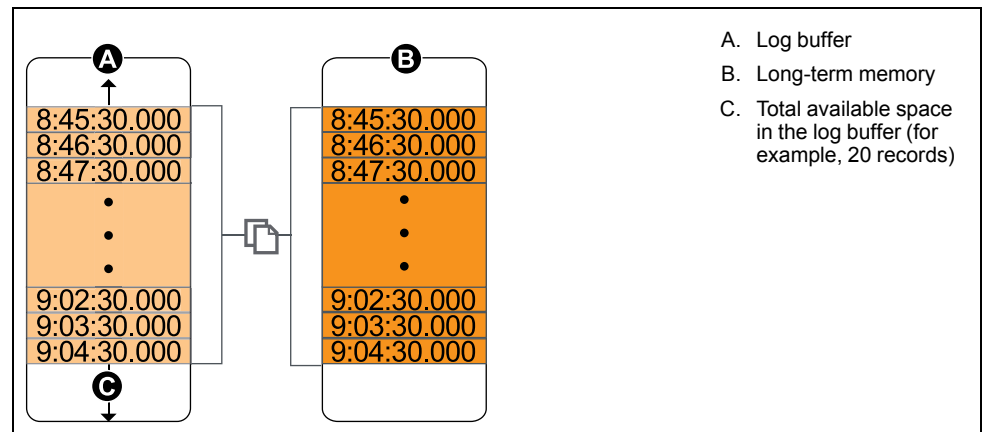

In this example, the log buffer equals the log depth and all the records are replicated in both the short-term memory and the long-term memory.

Example: Partially buffered log records replicated from short-term memory to long-term memory

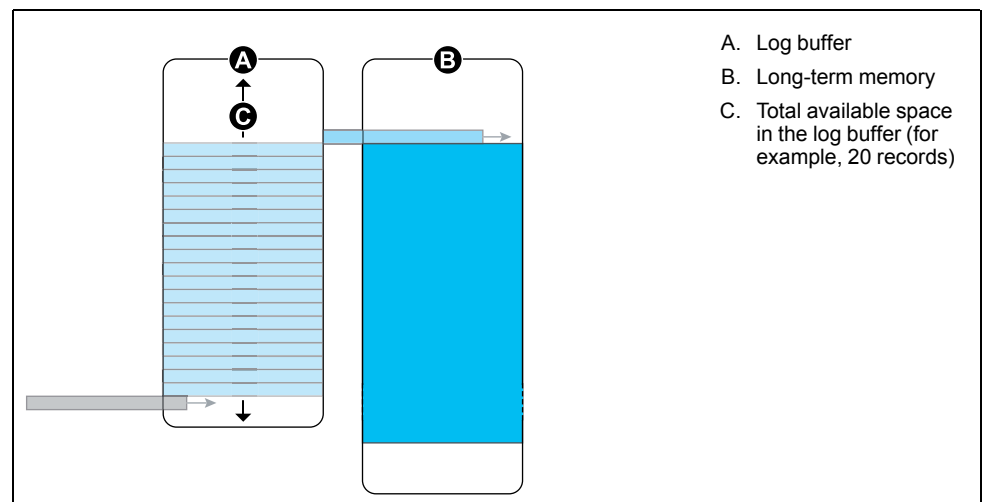

In this example, the buffer depth equals 20. The first record has already replicated to the long-term memory, making room in the log buffer for the new records (including the newest record, in gray).

Example: Resulting gaps in data when a partially buffered log is full

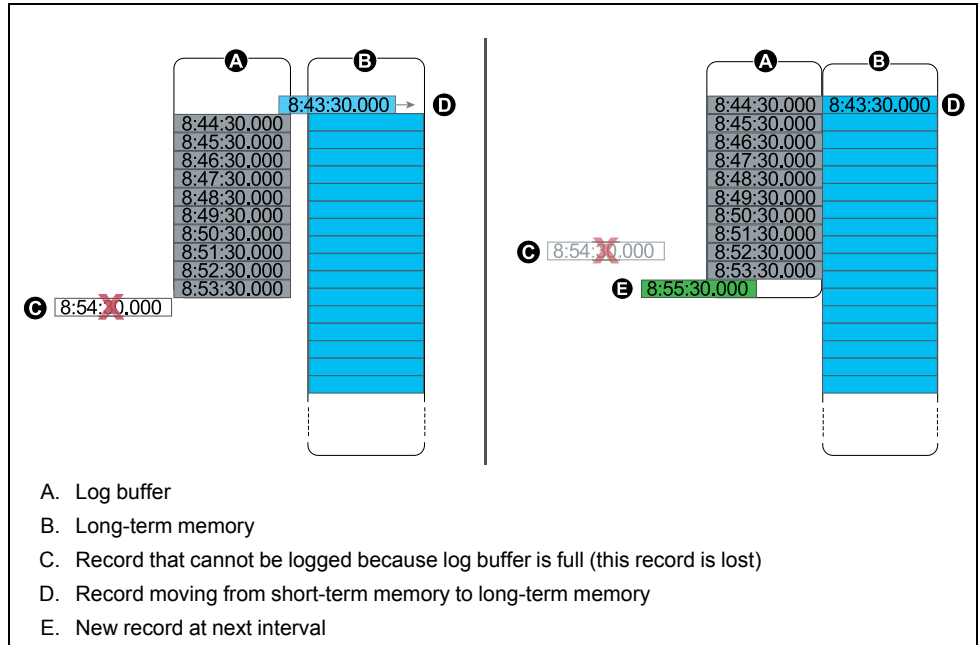

In the graphic on the left, the log buffer (A) is full, and the oldest record has not replicated to the long-term memory yet. This means that the new record (C) is not logged, and is permanently lost. In the graphic on the right, the oldest record (D) has been replicated to long-term memory, making space in the buffer. The new record at the next interval (E) is logged but there is a gap in the data for the lost record (C).

Changing log interval and depth settings using ION Setup

You can configure log intervals, log depths and buffer depths to optimize your memory usage.

Before you begin, make sure you understand:

- the structure of the meter’s logging framework
- the meter’s existing logging configuration
- your data logging requirements

Changing your meter’s log configuration deletes all existing records from that log.

NOTICE
DATA LOSS
Ensure that all important data has been recorded before configuring a log.
Failure to follow these instructions can result in data loss.

The default log settings are designed to meet the needs of most users.

This procedure provides the steps for configuring settings for a subset of data logs using the ION Setup Assistant. Configuring these settings for custom logs, and logs not listed in the **Logging > Memory** screen, is an advanced procedure; see the ION Setup help for more information.

1. Start ION Setup.
2. Open the Setup Assistant for your meter.
3. Navigate to the **Logging > Memory** screen.
4. Select the log you want to edit and click **Edit**.

5. Set the log depth and log interval as required for your logging needs.
 - **Log Interval:** you can change the interval units to seconds, minutes, hours or days.
 - **Log Depth:** You can set the depth in time (seconds, hours, days, etc.) or the number of records.

NOTE: For some log types, you only set the log depth (for example, waveform recorders).

Log Memory shows the estimated impact of the changes on the total size of the log and **Log Storage** displays the estimated available log memory on the meter.

NOTE: If you receive a message stating that there is not enough memory when you change a log's configuration, check the configuration of your meter's other logs. You may not have enough RAM, or short-term memory, to allow for the new configuration. You may need to use ION Setup Advanced mode to check the detailed configuration of your logs.

6. Click **Finish**.

In some case, you may see a **Next** button instead of **Finish**. In this case, the next screen allows you to configure the buffer depth for the log. The screen displays the overall log depth and a field for setting the log buffer depth. It also shows the impact of the **Buffer Depth** setting to your meter's short-term memory (RAM).

Time and timekeeping

Time overview

Your meter's internal clock is used for keeping time, timestamping data and determining intervals for time-based measurements.

Local meter time is displayed based on the meter's time sync source and the settings used for timezone and daylight savings time. You can configure and view your meter's date and time information through software such as ION Setup or through the meter display.

Your meter monitors time using the frequency of an internal oscillator or the frequency of the line power being measured. Your meter's battery powers the internal clock so that time is maintained when the meter is unpowered.

Your meter supports different time types and time synchronization methods to adjust its internal clock. To improve your meter clock's accuracy, you can use an external time reference such as a Global Positioning System (GPS) signal, Network Time Protocol (SNTP/NTP) server or Precision Time Protocol (PTP) Master.

Go to www.schneider-electric.com and download the *Time synchronization and timekeeping* technical note for more information about time formats and settings and the *ION Reference* for a detailed description of the Clock module and its operation.

Internal clock temperature compensation

The time accuracy of the meter has been improved by compensating for clock drift if the meter's operating temperature falls outside the optimum temperature range.

Your meter's internal clock is adjusted based on the internal clock temperature compensation parameters.

Time synchronization

Your meter's clock controls the timing of metering parameters, such as demand intervals or power quality measurement aggregation over time intervals.

Adjustments to the clock are made by synchronizing the meter's time with another time source, determined by the *Time Sync Source*. Time synchronization messages can be automatically generated and sent to your meter from your energy management system software or other time sources such as an SNTP/NTP server, PTP Master or GPS receiver. You can also manually trigger a time synchronization message from your energy management system or configuration software.

NOTE: To help maintain data integrity, some energy management systems impose a blackout rule where time synchronization messages near energy interval boundaries are ignored.

Supported time synchronization sources

Several time synchronization sources are available to your meter.

Time sync source	Description
Meter configuration software (ION Setup)	Configuration software can manually synchronize the time of your meter based on the clock of the computer running the configuration software. Configuration software synchronization is usually performed when the meter is initially commissioned.
Energy management system	Energy management systems can synchronize the time of your meter to be consistent with other meters on the network.
GPS receiver (IRIG-B) ¹	A GPS receiver using IRIG-B can synchronize the time of a meter up to ± 1 ms of Coordinated Universal Time (UTC). A dedicated serial network is required to implement a GPS scheme. For IRIG-B, one of your meter's digital inputs must be connected to the IRIG-B network, and the digital input must be configured for IRIG-B time synchronization in addition to configuring your meter's clock.
GPS over serial	A GPS receiver can synchronize the time of a meter up to ± 1 ms of Coordinated Universal Time (UTC). For GPS over serial, your meter's serial port must be connected to a GPS receiver, and the serial port communications must be configured with the correct protocol setting.
Simple Network Time Protocol (SNTP)	SNTP can synchronize the time of your meter up to ± 1 second of other meters on an Ethernet network. For SNTP time synchronization, your meter must be connected to an Ethernet network that has an active SNTP server and be configured with the server's information.
Network Time Protocol (NTP)	NTP can typically synchronize the time of a meter to ± 10 to 100 ms, depending on network configuration. To implement NTP time synchronization, your meter must be connected to an Ethernet network that has an active NTP server and be configured with the server's information.
Precision Time Protocol (PTP) ²	PTP can synchronize the meter time to ± 1 ms of other devices connected to a local area network. To implement PTP time synchronization, your meter must have PTP selected as the time sync source and be connected to an Ethernet network that has a valid PTP Master (Grandmaster Clock).

¹ Use the digital inputs located on the meter base for IRIG-B time synchronization and other high-accuracy applications.

² This clock precision assumes your meter is installed in a Star network topology only.

Clock source

The *Clock Source* setup register defines the meter's representation of a one second period, and can be set to:

LINE FREQUENCY

The meter monitors the ISO Grid Operation line frequency, and adjusts the one second period based on the measured line frequency. All devices connected to the grid network are synchronized to maintain a consistent time base. If a power outage occurs, the clock automatically synchronizes with the meter's internal crystal until power is restored. Once power is restored, the clock resynchronizes with the line frequency.

NOTE: Do not use LINE FREQUENCY when your meter is synchronized to an external time sync source.

INTERNAL

The meter clock is synchronized to the meter's internal crystal.

COMM

The meter clock is synchronized to an external time sync source. Use this for the *Clock Source* if:

- The *Time Sync Source* setup register is set to a serial communications port to receive GPS time synchronization signals.
- The *Time Sync Source* setup register is set to ETHERNET-PTP and your meter is installed in a trusted PTP network.
- The *Time Sync Source* setup register is set to IRIG-B.

Clock source time quality flag

The meter’s clock source time quality flag is primarily used to report time quality information for digital input events, such as status alarms, in Sequence-of-Events Recording (SER) applications.

The meter keeps track of the time difference between the meter’s internal clock and the time sync source.

When the meter’s Clock module’s *Use Clock Source Qual Flag* is set to USE FLAG, the Diagnostics module’s *Receiver Status* output register is set to:

- LOCKED if the time difference between the GPS time sync source or PTP master and meter clock is within ±1 ms of each other
- UNLOCKED if the time difference between the GPS time sync source or PTP master and meter clock is greater than ±1 ms of each other

PTP system setting recommendations

Your meter has been configured by default to be compatible in typical PTP supported systems.

In a PTP system, the grandmaster clock determines the reference time for the entire system. To ensure correct implementation and operation of the protocol, it is recommended to set the following parameters in your system grandmaster clock:

Parameter	Setting	Description
PTP device type	End to End transparent clock	A transparent clock that supports the use of the end-to-end delay measurement mechanism between slave clocks and the master clock.
Peer delay mechanism	2 step	A clock that provides time information using the combination of an event message and a subsequent general message.
Clock domain	0-3	A logical grouping of clocks that synchronize to each other using the protocol, but that are not necessarily synchronized to clocks in another domain
Ethernet switches	PTP compatible	All switches and other devices in the network must support IEEE 1588 PTP to achieve the stated time precision and accuracy

Star network topology

In addition to PTP system related settings, the accuracy of your meter clock also depends on your physical network configuration. A star network topology is required to achieve the level of clock precision specified.

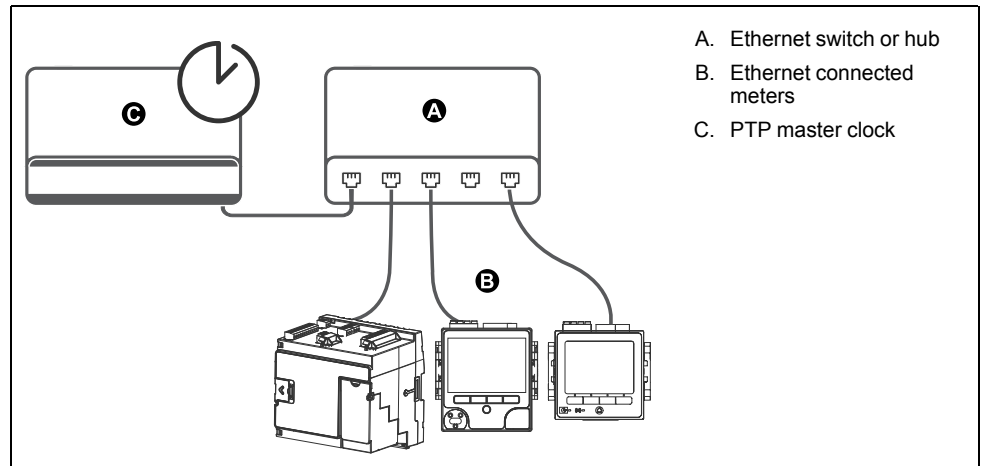

Configuring time information using ION Setup

You can set the time and date and configure the time synchronization settings using ION Setup.

NOTE: The clock screen is where you set the start day of the week for the time of use feature.

NOTE: You must manually adjust the date and time information if the device is installed in a different time zone location from the computer running ION Setup.

1. Start ION Setup.
2. Open the Setup Assistant for your device.
3. Navigate to **Clock** and select the **Timezone** tab.
4. Select any parameter and click **TimeSync** to synchronize your device's date and time with the computer that is running ION Setup.
5. Click the **DST Settings** tab to modify your meter's daylight savings time start and end dates, if required.

6. Select the parameter that you want to configure and click **Edit**. Enter the password if prompted.

Parameter	Value	Description
TimeZone	–	Sets the timezone based on the timezones available from the computer's operating system. NOTE: This is also where you can synchronize your meter's DST settings with the computer's.
Time Sync Type	UTC or LOCAL	Specifies the time format of the time sync message. UTC (Coordinated Universal time) is equivalent to Greenwich Mean Time (GMT). LOCAL is the local time with DST and time zone information applied. <ul style="list-style-type: none"> For SNTP/NTP and PTP time synchronization, set the Time Sync Type to UTC.
Time Sync Source	COM1, COM4, ETHERNET, ETHERNET - ION, ETHERNET - DNP, ETHERNET - PTP, IRIG-B	Sets which device port accepts time synchronization messages. Time synchronization messages on other ports are ignored. <ul style="list-style-type: none"> For GPS time synchronization, set the Time Sync Source to COM1 (or COM4). For SNTP/NTP time synchronization, set the Time Sync Source to ETHERNET. For ION time synchronization, set the Time Sync Source to ETHERNET-ION. For DNP time synchronization, set the Time Sync Source to ETHERNET-DNP. For PTP time synchronization, set the Time Sync Source to ETHERNET-PTP. For IRIG-B time synchronization, set the Time Sync Source to IRIG-B.
Clock Source	Internal, Line Freq, COMM	Sets the source for the clock: <ul style="list-style-type: none"> Internal: the meter's internal clock. Line Freq: the measured line frequency of the power system is the clock source. COMM: the meter's communication port (used by the IRIG-B, GPS or ETHERNET-PTP time sync source).
DST Offset	Numeric Bounded Format/Elapsed Interval Format	Specifies the amount of time the displayed local time is moved forward when entering Daylight Savings. A value of zero disables this feature and local time is not adjusted for DST.
Start of the Week	Monday - Sunday	Specifies the start day of the week used for Trending and Forecasting. NOTE: Changing the start day of the week clears all trending and forecasting data.

7. If using SNTP/NTP time synchronization, you must also enter the following information under **Communications > Advanced Ethernet > NTP**:

Parameter	Value	Description
Enable NTP Time Sync	NTP, SNTP, No	NTP: specifies NTP time synchronization. SNTP: specifies SNTP time synchronization. NOTE: SNTP is recommended for revenue-related applications. No: neither NTP nor SNTP time synchronization are used.
NTP Time Sync Interval	Numeric value or elapsed interval value	Specifies how often the meter synchronizes over SNTP. NOTE: This parameter is not used for NTP.
Event Logging Threshold (NTP and PTP only)	0.000001 to 1.000000	Specifies the minimum time difference (in seconds) for a time synchronization to be logged as an event. This parameter can be configured to help prevent the meter's event log from being flooded with time synchronization events.
NTP Server	Server IP address or domain name	Specifies the IP address (or fully qualified domain name if DNS is active) of the SNTP or NTP server.

- If using serial GPS time synchronization, you must also enter the following information under **Communications > Serial** settings:

Parameter	Description
Protocol	Select the GPS setting that matches your GPS receiver.
Baud rate	The recommended baud rate for GPS time synchronization is 9600 bps.
Serial port	The recommended stop bits/parity for GPS time synchronization is 8N1.

Configuring time information using the display

Use the meter’s display to configure a variety of time parameters.

NOTE: If your device is installed in a region where DST is observed, it is recommend to use ION Setup to configure the time zone for your locale.

- Go to **Setup Menu > Date/Time/Clock Setup > Date & Time Setup**.
- Configure your time and date formats, time zone offset, and daylight savings time offset. Press the down button to access the **Clock Setup** screen.
- Configure the clock and time synchronization source, and the time synchronization time format.

Date & time setup

Parameter	Values	Description
Time Format	12 H, 24 H	Specifies how the time is displayed
Date Format	MM/DD/YYYY, DD/MM/YYYY, YYYY/MM/DD	Specifies how the date is displayed
TZ Offset	-12:00:00 to 13:00:00	Sets the time zone of the meter’s location, relative to UTC
DST Offset	-3:00:00 to 3:00:00	Sets the daylight savings time offset of the meter’s location

Clock setup

Parameter	Values	Description
Clock Source	Internal, Line Freq, COMM	Specifies the time synchronization source
Time Sync Source	COM1, COM4, ETHERNET, ETHERNET - ION, ETHERNET - DNP, ETHERNET - PTP, IRIG-B	Specifies the port to receive time synchronization signals
Time Sync Type	UTC, Local	Specifies whether time synchronization signals are received in local time or UTC

Measurements

Energy

Your meter provides bi-directional, 4-quadrant, revenue accurate energy metering:

- kWh, kVARh, kVAh delivered and received
- kWh, kVARh, kVAh net (delivered - received)
- kWh, kVARh, kVAh total (delivered + received)
- Volt-squared-hours and amp-squared-hours
- Integration of any instantaneous measurement

Energy parameters can be logged automatically on a programmed schedule.

All energy values represent the total for all three phases.

Demand

Your meter supports several demand calculation methods, including block, rolling block, synchronized and predicted demand.

It can measure demand on any instantaneous value and record peak (maximum) demand with time and date information.

- kW, kVAR, kVA demand
- kW, kVAR, kVA peak demand
- Amps, Volts demand

Instantaneous measurements

Your meter provides one second and half-cycle true RMS readings.

Instantaneous readings include:

- 3-phase voltages (line-to-line, line-to-neutral): per phase and average
- Line-to-earth voltages per phase and V4, neutral-to-earth voltage
- 3-phase currents: per phase and average
- I4 and I5 currents, measured
- Residual current, calculated (I calc res)
- Active (kW), reactive (kVAR) and apparent (kVA) power: per phase and total
- Power factor per phase and total
- System frequency
- Voltage and current unbalance
- Phase reversal

Harmonics

Your meter provides harmonic distortion metering, recording and real-time values for all voltage and current inputs.

- Individual harmonics (including magnitude, phase angle phase and inter-harmonics) up to the 63rd harmonic
- Total even harmonic distortion (TEHD), total odd harmonic distortion (TOHD)
- Total harmonic distortion (THD), total demand distortion (TDD)
- K-factor, Crest factor

Min/max recording

Your meter records new minimum and maximum data every recording interval for a variety of values.

- Voltage and current
- kW, kVAR and kVA
- Power factor
- Frequency
- Voltage unbalance

Power quality

Your meter monitors the voltage channels, detects and records power quality events.

The meter measures and records:

- Sag/swells: ITIC/CBEMA and SEMI curves
- Transients: 20 microseconds or longer in duration on any voltage channel

Power quality standards compliance:

- EN50160, including Flicker
- IEC 61000-4-30 Class A
- IEEE 519

The meter supports advanced power quality features:

- Disturbance Direction Detection: the meter can capture sag/swell and transient disturbances, analyze the information and determine the direction of the disturbance relative to the meter. Determining the source of a disturbance more quickly and accurately helps prevent repeat occurrences and minimize facility downtime.
- COMTRADE: the meter can save waveform data in COMmon format for TRAnsient Data Exchange (COMTRADE) format, which is then available for download via FTP. This is intended for use in conjunction with IEC 61850.
- Setpoint learning: You can configure your meter to learn certain disturbance-related values, such as what constitutes a sag, swell, transient, or high or low setpoint.

Power and power factor

The sampled measurements taken at the meter's voltage and current inputs provide data for calculating power and power factor.

In a balanced 3-phase alternating current (AC) power system source, the AC voltage waveforms on the current-carrying conductors are equal but offset by one-third of a period (a phase angle shift of 120 degrees between the three voltage waveforms).

Power factor (PF)

Power factor (PF) is the ratio of real power (P) to apparent power (S).

PF is provided as a number between -1 and 1 or as a percentage from -100% to 100%, where the sign is determined by the convention.

$$PF = \frac{P}{S}$$

A purely resistive load has no reactive components, so its power factor is 1 (PF = 1, or unity power factor). Inductive or capacitive loads introduce a reactive power (Q) component to the circuit which causes the PF to become closer to zero.

True PF and displacement PF

The meter supports true power factor and displacement power factor values:

- True power factor includes harmonic content.
- Displacement power factor only considers the fundamental frequency.

NOTE: Unless specified, the power factor displayed by the meter is true power factor.

Apparent, active and reactive power (PQS)

Apparent power (S) is the capacity of your measured power system to provide active (real power, P) and reactive power (Q).

A typical AC electrical system load has both resistive and reactive (inductive or capacitive) components. Resistive loads consume real power (P). Reactive power (Q) is either consumed (inductive loads) or generated (capacitive loads).

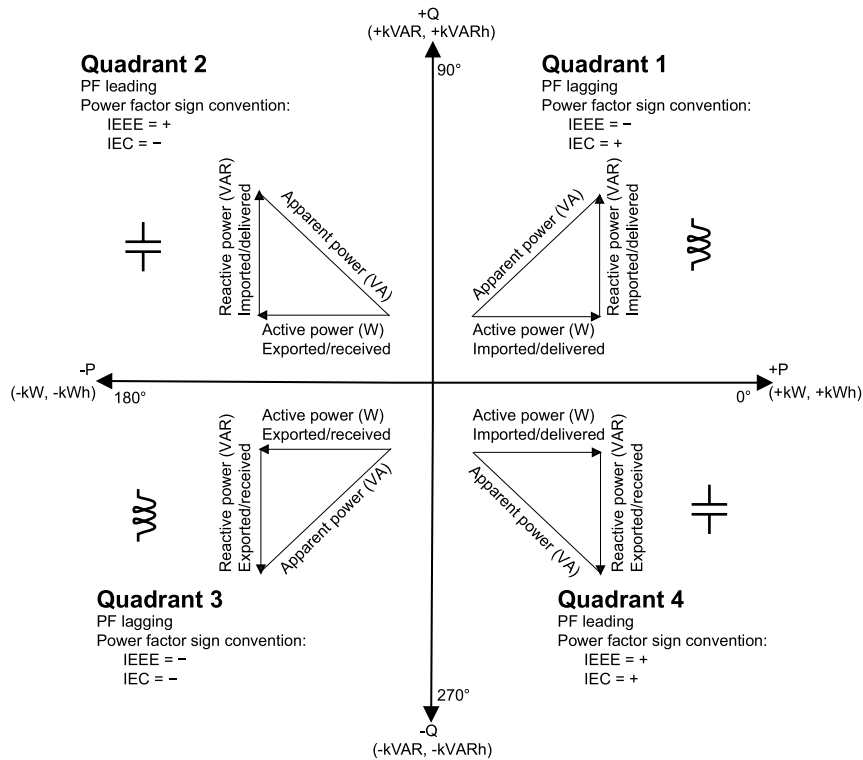

The units for power are watts (W or kW) for real power P, vars (VAR or kVAR) for reactive power Q, and volt-amps (VA or kVA) for apparent power S.

Positive real power P(+) flows from source to load, and negative real power P(-) flows from the load to the power source.

Current phase shift from voltage

Electrical current can lag, lead, or be in phase with the AC voltage waveform, and is typically associated with the type of load — inductive, capacitive or resistive.

For purely resistive loads, the current waveform is in phase with the voltage waveform. For capacitive loads, current leads voltage. For inductive loads, current lags voltage.

The following diagrams show how voltage and current waveforms shift based on load type under ideal (laboratory) conditions.

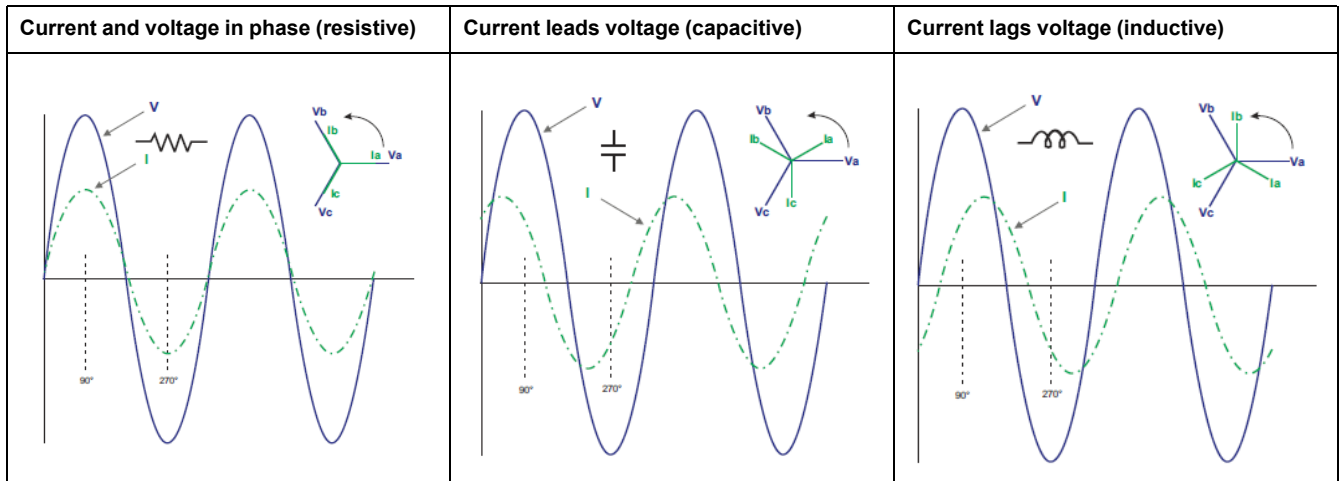

Power demand

Power demand is a measure of average power consumption over a fixed time interval.

NOTE: If not specified, references to demand are assumed to mean power demand.

The meter measures instantaneous consumption and can calculate demand using various methods.

Peak demand

Peak (or maximum) demand is the highest demand level recorded over the billing period.

Power utilities generally bill commercial customers based on their peak usage levels, called peak demand (in kW) and energy consumption (in kWh). Peak (or maximum) demand is the highest demand level recorded over the billing period. You can view peak demand values on your meter's display.

Your meter calculates the average current demand and kW, kVAR and kVA demand using sliding window demand methods. It supports coincident demand values when a peak demand is detected.

Your meter's default configuration is suitable for most applications, or you can customize it for your specific application. You can configure the minimum time between consecutive demand resets.

NOTE: If not specified, references to demand are assumed to mean power demand.

Peak demand reset lockout

The demand reset lockout time sets the minimum time allowed between consecutive demand resets; the meter ignores any attempts to reset demand that occur within the lockout period.

The peak demand reset lockout period is user-configurable (typical default value is 25 days).

See the ION Setup online help for instructions on how to configure demand peak and the demand reset lockout period on your meter.

See the ION Reference, available from www.schneider-electric.com, for detailed information on how Sliding Window Demand modules measure and calculate demand values.

Related Topics

- Meter resets

Sliding window demand

To calculate demand values, your meter uses the sliding window averaging (or rolling interval) method which divides the demand interval into a set number of subintervals of specified duration.

The demand is measured based on the average load level over the most recent set of subintervals. Sliding window demand also provides predicted demand values.

Examples of sliding window demand

This example shows two different ways of configuring a 15-minute demand interval:

- Single interval (also called block or timed block): the 15-minute demand interval is defined as a single subinterval with a duration of 15 minutes.
- Sliding window (also called rolling block): the 15-minute demand interval is defined as three subintervals with a duration of 5 minutes each. This method offers better response time than a single interval.

Single interval (block)

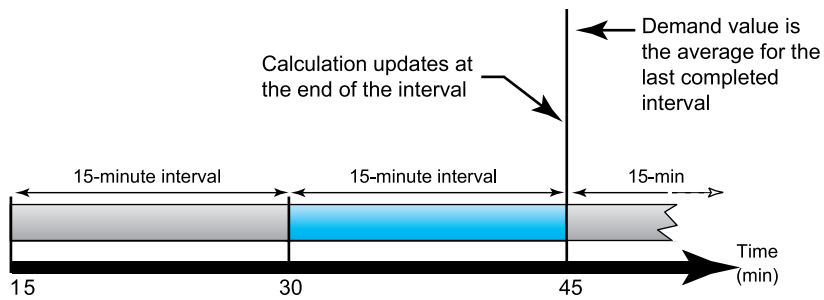

Sliding window (rolling block)

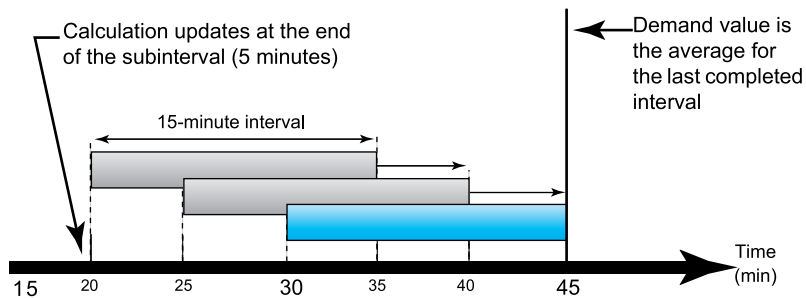

Incremental energy

Incremental energy allows you to define a start time, end time, and the time interval (increments) for incremental energy accumulation.

At the end of each interval, the energy accumulated during that period is stored. By default, the meter only records the previous interval's incremental energy and the instantaneous energy accumulations in the active interval.

The first interval of incremental energy accumulation begins at the specified start time. Incremental energy ends at the specified end time, which may result in a truncated interval if the interval duration does not divide evenly into the overall incremental energy duration. For example, an interval duration of three hours with

an overall duration of five hours truncates the last interval duration to two hours. The latest value for the specified end time is midnight (24:00).

Your start time must be before the end time and after midnight, and the period over which incremental energy is accumulated cannot include midnight. This is because your meter's start and end times are defined relative to midnight.

Start: 6AM, End: 12AM, interval: 3 hrs	Incremental energy accumulates from 6AM to midnight in intervals of 3 hours.
Start: 6AM, End: 2AM, interval: 3 hrs	Incremental energy will not function. End time must be after start time and before or equal to midnight.

Incremental energy helps provide information for analyzing energy and power usage against present or future utility rates, and is useful for measuring energy consumption by shift or for a specific process.

When configuring incremental energy, shorter incremental energy periods provide more granular data which can make the data easier to use for comparison purposes.

Incremental energy example

- Start time: 8AM or 08:00
- End time: 12AM or 24:00
- Interval: 420 minutes (7 hours)

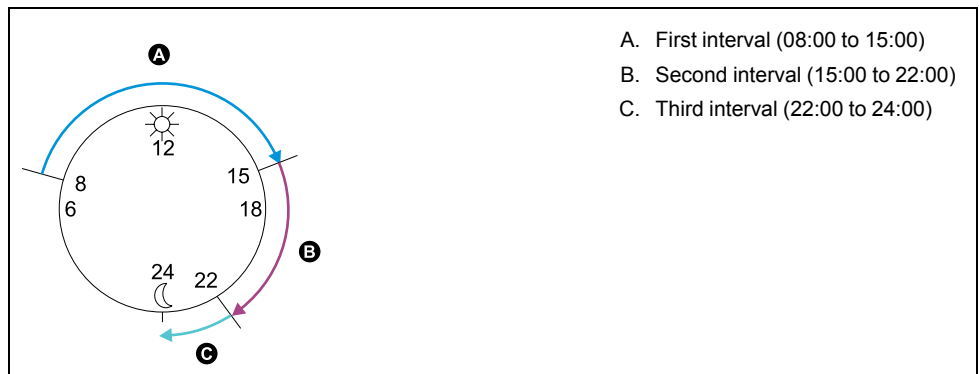

- A. First interval (08:00 to 15:00)
- B. Second interval (15:00 to 22:00)
- C. Third interval (22:00 to 24:00)

The first incremental energy interval is from 8AM (start time) to 3PM, and is 7 hours long. The second incremental energy interval is from 3PM to 10PM, and is also 7 hours long. The third interval is from 10PM to 12AM, and is only 2 hours long because 12AM is the specified end time. These intervals repeat every 24 hours until the configuration is changed or incremental energy feature is disabled.

Configuring incremental energy using ION Setup

You can configure incremental energy using ION Setup.

1. Start ION Setup.
2. Open the Setup Assistant for your meter.
3. Navigate to **Energy Applications > Incremental Energy**.
4. Select **Status** and click **Edit**. The **Incremental Energy Setup** screen is displayed.
5. Select **Enable** to display parameters for configuration.

- Select the parameter to configure.

NOTE: Configuring any parameter resets the incremental energy values recorded by your meter.

Parameter	Range	Description
Start time	12:00 am to 11:59 pm	The incremental energy first interval's start time. The start time must be prior to the end time for energy accumulation.
End time	12:01 am to 12:00 am	The end time for incremental energy. The end time must be after the start time and be less than or equal to 12AM (midnight).
Interval duration	Configurable	The increment period for the incremental energy duration.

- Click **OK** to save your changes.

Conditional energy

Conditional energy allows you to define an accumulation period for real and reactive energy using one of your meter's digital inputs.

You can use conditional energy to track four-quadrant accumulated energy during a specific period. For example, you can track accumulated energy values during a particular process that is controlled by a programmable logic controller (PLC).

Conditional energy is accumulated until it is reset. The conditional energy reset date and time information is stored in the meter's event log.

Related Topics

- Meter resets

Configuring conditional energy using ION Setup

You can enable and configure conditional energy settings using ION Setup.

When configuring your meter, the configuration interface may show all of the possible ports, regardless of what is physically available on your meter.

One of your device's digital inputs must be connected and configured to define when conditional energy is accumulated.

- Start ION Setup.
- Open the Setup Assistant for your meter.
- Navigate to **Energy Applications > Digital Input Based**. Review the digital inputs assigned to applications to help ensure there are no conflicting usages.
- Select **Conditional Energy** and click **Edit**. The **Conditional Energy Setup** screen is displayed.
- Select **Enabled** to enable the conditional energy feature.
- Click **Select** to define the digital input. The input's state determines whether conditional energy is accumulated. When this digital input is on, conditional energy is accumulated.

NOTE: It is recommended to set **Assigned Input** to No Connection to disable the conditional energy feature by removing any port associations.

- Click **OK** to save your configuration.

Trending and forecasting overview

Trending and forecasting is a feature on your device that predicts the next set of measured or calculated data by plotting and analyzing trends in historical data.

Trending and forecasting data is a useful tool to help analyze changes in load and power quality and forecasting values such as demand. For your meter's trending and forecasting feature to work, you only need to give the meter time to accumulate data.

Trending and forecasting implementation

Data used for trending and forecasting is logged for specific intervals:

- Every hour for the last 24 hours
- Every day for the last month
- Every week for the last 8 weeks
- Every month for the last 12 months

The following parameters are configured for trending and forecasting using ION Setup:

kW sd del-rec (demand)	Freq (frequency)
VII ab	I a mean
VII bc	I b mean
VII ca	I c mean
VII avg	I avg mean

You can configure the start day of the week for trending and forecasting using the **Clock** setup assistant in ION Setup.

Viewing trending and forecasting data on your meter's webpages

You can select data for forecasting and trending and view the resulting information using your meter's webpages.

For trending and forecasting to operate, your meter must have accumulated data for at least two of the specified intervals; for example, if you want to view a daily graph, your meter must have accumulated data for at least two previous days before the present day.

1. Log in to your meter's webpages
2. Click **Monitoring > Trending & Forecasting**
3. Select the **Target** and **Interval**. The graph for the selected data is displayed.

Resets

Meter resets

Resets allow you to clear various accumulated parameters stored on your meter, reinitialize the meter or reinitialize meter accessories.

Meter resets clear your meter’s onboard data logs and other related information. Resets are typically performed after you make changes to the meter’s basic setup parameters to clear invalid or obsolete data to prepare the meter for active service.

Option modules reset

Perform an option module reset if your option modules are not communicating with your meter.

During an option module reset, the option module may not operate normally, and digital and analog outputs may change state.

⚠ WARNING
UNINTENDED OPERATION
Do not use the meter for critical control or protection applications where human or equipment safety relies on the operation of the control circuit.
Failure to follow these instructions can result in death, serious injury or equipment damage.

You can reset your meter’s option module bus using ION Setup or through the display. This power cycles all the modules attached to your meter. If you have queued firmware updates for option modules on your meter’s internal FTP site, the firmware updates are performed.

By default, your meter is configured to automatically perform an option module bus reset to help keep the option modules operating normally. Contact Technical Support for instructions on changing this default configuration.

Available resets

You can perform various meter resets using ION Setup, the meter webpages or through the display.

Reset	Description
Master Reset	<ul style="list-style-type: none"> • Clears all cumulative and derived quantities from the meter, including: demand, peak demand, energy, revenue and test mode parameters. • Clears meter event and waveform logs. • Clears COMTRADE waveform records stored in the meter’s internal FTP server. • Clears meter data logs.
Peak Demand Reset	Clears meter peak demand values. NOTE: The peak demand reset has a lockout period that sets the minimum time allowed between consecutive resets.
Min/Max Reset	Clears all accumulated maximum and minimum values stored in the meter.
Digital Input Count Reset	Clears the digital input status change counters.
Harmonics Min/Max Reset	Clears all accumulated maximum and minimum harmonics values stored in the meter.
Disturbance Count Reset	Clears the sag/swell event counter. The sag/swell event counter counts the number of sag/swells that have occurred since power-up or the last reset to provide power quality information to energy management systems.

Reset	Description
EN50160 Reset	Clears all EN50160 parameters and statistics accumulated in the meter.
Option Modules Reset	Resets communications to expansion modules connected to the meter.
Conditional (Cnd) Energy Reset	Clears the conditional energy values stored in the meter.
Input Metering Reset	Clears the input metering values stored in the meter.

Related Topics

- Peak demand
- Conditional energy
- Input metering

Performing meter resets using ION Setup

You can perform meter resets on your meter using ION Setup.

Revenue-locked meters must be unlocked to perform resets that impact revenue data.

Meter resets clear the meter's onboard data logs and other related information.

NOTICE

DATA LOSS

Ensure all important data from the device has been retrieved before performing a reset.

Failure to follow these instructions can result in data loss.

1. Start ION Setup.
2. Open the Setup Assistant for your meter.
3. Select the **Verification** screen.
4. Select **Normal Mode** and click **Display**.
5. Select the desired tab in the **Normal Mode** dialog box. Depending on the tab selected, different resets are available.

Tab	Reset available
Energy	Master Reset
Rolling Demand	Peak Reset Master Reset
Volts, Amps and Power	Master Reset
Conditional Energy	Cnd Reset Master Reset
Input Metering	IM(n) Reset NOTE: n is the input metering number, for example IM1.

6. Click the appropriate button to perform the reset. For some resets, the meter indicates that the reset is in progress.

Do not configure or power down your meter until it indicates that the reset is complete or some parameters may not be completely reset.

Performing meter resets using the meter webpages

You can perform meter resets using the meter webpages.

Meter resets clear the meter’s onboard data logs and related information.

<i>NOTICE</i>
<p>DATA LOSS</p> <p>Ensure all important data from the device has been retrieved before performing a reset.</p> <p>Failure to follow these instructions can result in data loss.</p>

1. Connect to your meter’s webpages.
2. **Control > Resets.**
3. Click **Reset** for the values you want to clear.

Parameter	Description
Master Reset	<ul style="list-style-type: none"> • Clears all cumulative and derived quantities from the meter, including: demand, peak demand, energy, revenue and test mode parameters. • Clears meter event and waveform logs • Clears COMTRADE waveform records stored in the meter’s internal FTP server. • Clears meter data logs.
Peak Demand Reset	<p>Clears meter peak demand values.</p> <p>NOTE: The peak demand reset has a lockout period that sets the minimum time allowed between consecutive resets.</p>
Min/Max Reset	Clears all accumulated maximum and minimum values stored in the meter.
Digital Input Count Reset	Clears the digital input status change counters.
Harmonics Min/Max Reset	Clears all accumulated maximum and minimum harmonics values stored in the meter.
Disturbance Count Reset	Clears the sag/swell event counter. The sag/swell event counter counts the number of sag/swells that have occurred since power-up or the last reset to provide power quality information to energy management systems.
EN50160 Reset	Clears all EN50160 parameters and statistics accumulated in the meter.

Performing meter resets using the display

You can perform meter resets using the display after entering a valid password.

Revenue-locked meters must be unlocked to perform resets that impact revenue data.

Your meter’s digital and analog outputs may change state or may not function during resets.

 WARNING
<p>HAZARD OF UNINTENDED OPERATION</p> <p>Do not use the meter for critical control or protection applications where human or equipment safety relies on the operation of the control circuit.</p> <p>Failure to follow these instructions can result in death, serious injury or equipment damage.</p>

Meter resets clear the meter's onboard data logs and related information.

NOTICE

DATA LOSS

Ensure all important data from the device has been retrieved before performing a reset.

Failure to follow these instructions can result in data loss.

1. Press the **Home** button on the display.
2. Navigate to **Setup Menu > Resets**.
3. Press Select.
4. Press Edit. Enter your meter's password, if prompted.
5. Press the up or down icons to navigate available resets. A gray bar appears behind the active selection.

Reset	Description
Master Reset	<ul style="list-style-type: none"> • Clears all cumulative and derived quantities from the meter, including: demand, peak demand, energy, revenue and test mode parameters. • Clears meter event and waveform logs. • Clears COMTRADE waveform records stored in the meter's internal FTP server. • Clears meter data logs.
Peak Demand Reset	Clears meter peak demand values. NOTE: The peak demand reset has a lockout period that sets the minimum time allowed between consecutive resets.
Min/Max Reset	Clears all accumulated maximum and minimum values stored in the meter.
Digital Input Count Reset	Clears the digital input status change counters.
Harmonics Min/Max Reset	Clears all accumulated maximum and minimum harmonics values stored in the meter.
Disturbance Count Reset	Clears the sag/swell event counter. The sag/swell event counter counts the number of sag/swells that have occurred since power-up or the last reset to provide power quality information to energy management systems.
EN50160 Reset	Clears all EN50160 parameters and statistics accumulated in the meter.
Option Modules Reset	Resets communications to expansion modules connected to the meter.

6. To select the item(s):
 - Press Select for Reset, or
 - Press the up and down icons simultaneously.
7. Press Select to accept the change.

When you select **Master Reset**, the message ALL RECORDED DATA WILL BE LOST. RESET SELECTED PARAMETERS? is displayed.

8. Press Select to confirm.

Maintenance

Maintenance overview

The meter does not contain any user-serviceable parts. If the meter requires service, contact your local Schneider Electric Technical Support representative.

NOTICE

METER DAMAGE

- Do not open the meter case.
- Do not attempt to repair any components of the meter.

Failure to follow these instructions can result in equipment damage.

Do not open the meter. Opening the meter voids the warranty.

Firmware and templates

Firmware and templates overview

Firmware is the meter's operating system that enables the functions of your meter.

You can view the firmware version on the display, webpages and through ION Setup. The firmware includes a digital signature which helps ensure the authenticity of the firmware.

The meter template defines features such as power measurement and analyzing functionality. Your meter ships from the factory with a default template, or you can customize the template to create features specific to your application.

You can upload different firmware versions and templates. When new firmware is available you can upgrade to the latest version to get added features and functionality. You must load a meter template as part of the firmware upgrade process. Save your meter's existing template before performing a firmware upgrade and then reload it back onto the meter if you do not want to change your meter's template.

Firmware updates and new factory templates are available for download from www.schneider-electric.com.

The remote display and options modules use firmware information from the meter, but may also need to have their internal firmware updated to support new or improved features. To update the remote display or option module firmware you need to copy the file onto your meter's internal FTP server. Go to www.schneider-electric.com to download firmware files.

Typical workflows

To update your meter to the latest available firmware and factory template:

- Download the latest firmware and template for your meter.
- Load the firmware onto your meter; the firmware upgrade process includes upgrading the meter template.

To take an existing meter out of service and replace it with a new meter:

- Save the template from the existing meter
- Load the existing meter's template onto the new meter; the new meter will now have the customized features from the existing meter.

To update your meter's firmware without updating your meter's template:

- Save your meter's template.
- Download the latest firmware.

- Load the firmware onto your meter. When prompted for a template file, select the template you saved from your meter.

To update the firmware on your meter's remote display:

- Download the display firmware.
- Load the firmware onto the meter's internal FTP site using either an FTP program or ION Setup. The results of the firmware update are stored in the meter's event log.

To update the firmware on your meter's option module(s):

- Download the option module firmware; make sure that the firmware matches the option module type.
- Load the firmware onto the meter's internal FTP site using either an FTP program or ION Setup.
- Power cycle or perform an option bus reset to start the option module firmware update.

NOTE: If the meter is power cycled or an option module reset is performed while there are option module firmware upgrade files loaded on the meter's FTP site, the option module firmware is upgraded.

Visit the company website at www.schneider-electric.com and search for your meter type to see the available firmware and templates.

See the online ION Setup help for instructions on how to load meter templates.

Laptop computer upgrade considerations

The connection between the laptop and the device must be maintained in order for the upgrade to proceed.

Laptop computers generally have different default power properties than desktop computers.

If the laptop's hard disk shuts down or the laptop enters system standby mode, this connection is broken and the upgrade procedure must be restarted.

If you are upgrading your meter's firmware using a laptop computer, follow these guidelines:

- Plug the laptop computer into a wall outlet. Do not run the laptop on its battery.
- Configure the laptop's hard disks so that they do not shut down after a certain period of time (for example, set to "never").
- Turn off the laptop's power suspension (for example, system stand-by) and hibernate options.
- Disable the laptop's option to power down when it is closed. This prevents a shut down if the laptop is accidentally closed.
- Disable the laptop's screen saver as they can burden the CPU.

Firmware upgrade considerations

Ensure that the firmware version you are upgrading to is compatible with your meter, and that the version number is greater than your existing firmware (or else you will downgrade your meter).

Your meter's existing template may not work with different firmware versions if significant meter features have been added or modified.

Your firmware upgrade files have digital signature confirmation to help ensure your firmware's authenticity. Once you have upgraded your firmware to a version that uses digital signature confirmation, you cannot downgrade to an earlier firmware version that did not use digital signature authentication.

Remote display (RMD) upgrade behavior

Your meter's remote display will upgrade as soon as the upgrade file is put in the remote display upgrade folder on your meter's internal FTP site. It is deleted as part of the upgrade process.

NOTE: If your meter's remote display loses power during firmware upload, the display will revert to its original firmware and you will have to reload the firmware file.

The results of your remote display firmware upgrade are stored in your meter's event log. Detailed information about your remote display, such as serial number and firmware version is provided in the Factory module.

See the *ION Reference*, available from www.schneider-electric.com, for more information about the Factory module.

Option module(s) upgrade behavior

To upgrade option modules, you must load the upgrade file into the appropriate folder on the meter's internal FTP site. The upgrade is triggered by either a power cycle or option module reset. After the upgrade is performed, the upgrade file is deleted from the meter's internal FTP site before the option module is reset to run the new firmware. The option module firmware will not upgrade if more than one upgrade file is in the folder. The upgrade file must be the correct file type and match the type of module being upgraded.

All option modules do not perform their regular functions during firmware upgrade. If more than one option module is being upgraded, the firmware on the option module closest to the meter is done first, then the next closest, proceeding to the furthest module from the meter base requiring upgrading. A single option module firmware upgrade should not take more than five minutes.

The option module upgrade results are stored in your meter's event log. Detailed information about the option module, such as serial number and firmware version is provided in the Factory module. Information about the option module type and details of the option module's state is provided in the Diagnostics module.

See the *ION Reference*, available from www.schneider-electric.com, for more information about the Factory and Diagnostic modules.

Accumulated energy values and upgrades

The firmware upgrade process clears accumulated energy values in the meter.

If you want to retain these values across a firmware upgrade, you can use the Register Edit feature in ION Setup to manually restore pre-upgrade values back to your meter.

Editing accumulated energy values using ION Setup

You can edit energy values such kWh and kVARh using ION Setup.

NOTE: Ensure you have recorded accumulated energy values before upgrading your meter's firmware. You can then re-enter these values after the upgrade.

1. Start ION Setup.
2. Open the Setup Assistant for your meter.
3. Select the **Template** screen.
4. Click the **Register Edit** tab, click **Energy** then click **Display**. Enter your meter's password (if prompted) and click **OK**. The Register Editor screen displays.
5. Click **Edit** to enable editing.

6. Enter values for kWh, kVAh and kVARh as required. Click **Send** to finish.

NOTE: Only values that have the checkbox selected will be sent to the meter.

7. Click **Close** to close the Register Editor screen.

Loading meter firmware using ION Setup

You can load firmware onto your meter using ION Setup.

You can download firmware for your meter from www.schneider-electric.com.

You must load a meter template as part of the firmware upgrade process. You can save your meter's existing template by navigating to **Template > Save to PC** in the ION Setup Assistant and clicking **Save** to save your meter's template as a .DCF file. You can also use a template that you have saved from another meter of the same type, or download a factory template from www.schneider-electric.com.

Ensure that you record your meter's user and password information in a secure location before upgrading the meter's firmware. If your meter's user and password information is lost, you must return the meter for factory reconfiguration, which resets your meter to its factory defaults and destroys all logged data.

Any digital and analog outputs associated with your device may change state during a firmware upgrade.

⚠ WARNING

UNINTENDED OPERATION

Do not use this device for critical control or protection applications where human or equipment safety relies on the operation of the control circuit.

Failure to follow these instructions can result in death, serious injury, or equipment damage.

Loading firmware or template onto your meter clears the meter's recorded data.

NOTICE

DATA LOSS

Ensure that all important data has been recorded before uploading firmware or a template to your device.

Failure to follow these instructions can result in data loss.

1. Obtain the meter firmware (.UPG) and framework (.DCF or .FWN) that you want to load onto your meter. Save the files where they can be accessed by the computer running ION Setup.
2. Start ION Setup.
3. Open the Setup Assistant for your meter.
4. Select the **Template** screen.
5. Click the **Firmware Upgrade** tab, then click **Upgrade**. Enter your meter's password (if prompted) and click **OK**.

NOTE: If you want to retain customized meter template settings, other than those listed in the Template Paste Options dialog box (see Step 8), click on the **Save to PC** tab and click **Save**. Save your template as a .DCF file. Select this file in Step 7 instead of the file obtained from the website.

6. Navigate to the meter firmware (.UPG) file and click **Open**. Enter your ION Setup password when prompted and click **OK**.

7. Navigate to the meter framework (.DCF or .FWN) file and click **OK**. The Template Paste Options dialog box appears.
8. Select the check boxes for the settings you want to retain (not overwrite) and click **OK**.

A dialog box describes the template upload and firmware upgrade progress, verifies the firmware, and finishes with an overview stating whether the firmware and framework were successfully uploaded onto your meter.

Post-requisite:

After upgrading your meter's firmware or template, make sure that the meter's settings, either for existing functionality or new features, are appropriate for your system.

Loading webpages using ION Setup

You can upgrade your meter's webpages using ION Setup with an Ethernet connection.

You must have:

- Your meter's webpage upgrade files (.zip folder). Go to www.schneider-electric.com to download upgrade files.
- FTP access to your meter from the computer running ION Setup.

1. Obtain the webpage upgrade files (.zip folder) that you want to upload onto your meter. Save the files where they can be accessed by the computer running ION Setup.
2. Start ION Setup.
3. Open the Setup Assistant for your meter.
4. Select **Template > Web**.

NOTE: You can preview meter webpages using the **Test Web Viewing** feature. Select an IP addressing method from the drop-down menu to generate a test link using your default web browser.

5. Click **Upload** to navigate to the folder (.zip) containing the meter upgrade files. Select the folder and click **Open**.
6. An ION Setup dialog box will open. Click **Yes** to confirm uploading of the webpage files.

NOTE: The upload process replaces files with matching filenames only.

Confirmation of uploaded files will be displayed in the bottom status bar.

Loading webpages using FTP

You can upgrade your meter's webpages using your meter's internal FTP site.

You must have:

- Your meter's webpage upgrade files. Go to www.schneider-electric.com to download upgrade files.
- Access to your meter's internal FTP site.

1. Connect to your meter's internal FTP site and open the webpages (**web**) folder.
2. Navigate to the location on your local machine where you saved the webpage upgrade files.

NOTE: Extract the contents of the upgrade file.

3. Drag the **resources** and **examples** folders into the **web** folder. Confirm to overwrite existing files when prompted.
The files are immediately transferred to the meter.

Loading remote display firmware using ION Setup

This procedure is specific to meters with a remote display.

You can load updates to your meter's remote display firmware using ION Setup over an Ethernet connection.

You must have:

- Your meter's Remote Display firmware file (.BIN). You can download update files from www.schneider-electric.com.
- The remote display connected to your meter.
- FTP access to your meter from the computer running ION Setup.

NOTE: If your meter's remote display loses power during firmware upload, the display will revert to its original firmware and you will have to reload the firmware file.

1. Obtain the Remote Display firmware file (.BIN) that you want to load onto your display. Save the files where they can be accessed by the computer running ION Setup.
2. Start ION Setup.
3. Open the Setup Assistant for your meter.
4. Select the **Template** screen.
5. Click the **Firmware Upgrade** tab, then click **Upgrade**. Enter your meter's password (if prompted) and click **OK**.
6. Navigate to where you have stored the remote display firmware. Select the Remote Display firmware file (*.BIN) as the file type.
7. Select the remote display firmware (.BIN) file and click **Open**.
8. Enter your ION Setup password when prompted and click **OK**.

A dialog box describes the firmware upgrade progress, verifies the firmware, and finishes with an overview stating whether the firmware was successfully uploaded.

Loading remote display firmware using FTP

You can upload firmware to your meter's remote display by loading the firmware upgrade file onto your meter's internal FTP site.

You must have:

- Your meter's remote display firmware upgrade (.BIN) file. You can download upgrade files from www.schneider-electric.com.
- The remote display connected to your meter, and have access to your meter's internal FTP site.

1. Connect to your meter's internal FTP site.
2. Open the remote display upgrade (rmdUpg) folder.
3. Drag the remote display firmware file into the remote display upgrade folder. The file is immediately transferred to the remote display, and is not stored on the meter.
4. Watch your meter's display to confirm the firmware upgrade is taking place.

5. Review the remote display firmware upgrade details stored in the meter's event log to confirm that the upload was successful.

Related Topics

- Event log overview
- Remote display troubleshooting icons
- Accessing your meter's FTP server

Loading option module firmware using ION Setup

You can upload firmware to your meter's option modules using ION Setup over an Ethernet connection.

You must perform the upload process separately for each type of module.

You must have:

- Your meter's Option Module firmware file (.S19). You can download upgrade files from www.schneider-electric.com.
- The option module connected to your meter.
- FTP access to your meter from the computer running ION Setup.

Your meter's digital and analog outputs may change state during a firmware upgrade. Option modules are offline during an option module firmware upgrade; they will not communicate to the meter and the outputs may change state during the upgrade process.

▲ WARNING

UNINTENDED OPERATION

Do not use this device for critical control or protection applications where human or equipment safety relies on the operation of the control circuit.

Failure to follow these instructions can result in death, serious injury, or equipment damage.

NOTE: If your meter's option module loses power during firmware upload, the option module will revert to its original firmware and you will have to reload the firmware file.

1. Obtain the Option Module firmware files (.S19) that you want to load onto your option module(s). Save the files where they can be accessed by the computer running ION Setup.
2. Start ION Setup.
3. Open the Setup Assistant for your meter.
4. Select the **Template** screen.
5. Click the **Firmware Upgrade** tab, then click **Upgrade**. Enter your meter's password if prompted and click **OK**.
6. Navigate to where you have stored the option module firmware. Select the Option Module firmware file (*.S19) as the file type.
7. Select the option module firmware file and click **Open**. An ION Setup window will open. Click **Yes** to confirm the firmware upgrade.
8. The Option Card Upgrade window opens. Select the Slot that corresponds to the Option Module type. You can select multiple slots for the same option module type.

9. Click **Start**.

A dialog box describes the firmware upgrade progress, verifies the firmware, and finishes with an overview stating whether the firmware was successfully uploaded.

Test mode

Test mode is typically used for verifying meter functions.

The meter is usually reading data from a test power supply while function verification is performed.

The values shown in the test mode display screens represent different accumulators than those shown in norm or alt mode (although they perform some of the same basic measurements). The test mode display values are for accuracy checking purposes; they only accumulate while the meter is in test mode.

You can create custom test mode screens and modify the existing test mode screens.

NOTE: You cannot place revenue-locked meters into test mode.

Several things to note about test mode:

- All of the billing quantities that are recorded when the meter is in Normal mode stop accumulating when the meter is switched to test mode – the data is sent to special test mode registers instead.
- The values accumulated in these test registers are displayed on the test mode displays and in ION Setup.
- The regular normal mode billing registers are unaffected while the meter is in test mode; accumulation of this data continues as soon as you exit test mode.
- All test registers are reset to zero when you exit test mode.

Test mode default screens

Your meter has default test mode display screens.

NOTE: You can modify the test mode display screens or add custom screens using ION Setup.

Screen	Description
Demand test	This screen shows test mode kW delivered and received values. Both quantities are produced from a sliding window (rolling block) demand calculation.
Reactive energy test	This screen shows test mode kVARh delivered and received values.
Active energy test	This screen shows test mode kWh delivered and received values.

Putting your meter in test mode using the display

You can put your meter into test mode using the display.

NOTE: You cannot place a revenue-locked meter into test mode.

1. Press the Home button.
2. Press **Up** or **Down** to navigate to **Normal Display Mode**.
3. Press **Select**.
4. Press **Down** to navigate to **Test Mode**.
5. Press **Select** to enter the **Test Mode Screens**. Enter the meter password if prompted and press **Select**.
The **Test Mode** menu displays briefly before switching to the first **Test Mode** screen.

6. View the test mode screens by pressing **Up** or **Down**.
7. Press the Home button to return to **Test Mode Screens**. Press **Down** to highlight **Exit Test Mode**, then press **Select**.

Putting your meter in test mode using ION Setup

You can put your meter into test mode using the ION Setup.

NOTE: You cannot place a revenue-locked meter into test mode.

1. Start ION Setup.
2. Open the Setup Assistant for your meter.
3. Navigate to **Verification** and select the **Verification** tab.
4. Select **Test Mode** and click **Display**.
Your meter is now in test mode, and the **Test Mode** screen is displayed.
5. Select the different tabs to view your meter’s test mode values and modify test mode parameters.
6. Click **Close** to take your meter out of test mode.

Test mode data and parameters available through ION Setup

Tab	Data	Parameters
Energy	<ul style="list-style-type: none"> • kWh, kVARh, kVAh delivered and received • Loss compensation status 	<ul style="list-style-type: none"> • Force TLC (transformer loss compensation) • Scaling • Test Reset
Rolling Demand	<ul style="list-style-type: none"> • kW and kW peak demand • Test demand settings 	<ul style="list-style-type: none"> • Peak Reset • Test Reset
Volts, Amps and Power	<ul style="list-style-type: none"> • kW, kVAR • Harmonics • Average, total values • Power factor, frequency 	<ul style="list-style-type: none"> • Force TLC (transformer loss compensation) • Loss Mode • Test Reset

Device-specific information

Manufacturing-related information about the meter is available from the Factory module or through Modbus commands.

The meter’s Factory module stores meter details such as device type, serial number and vendor name. You can use ION Setup in advanced mode to view the contents of the Factory module’s setup registers. Similarly, you can use Modbus commands to read the Modbus registers mapped to the corresponding Factory module’s registers.

NOTE: Not all ION device setup registers are mapped to Modbus registers by default.

Other device-specific details, such as Product Code, are not stored in the Factory module. Product Code (also known as Modbus Product ID) is a number that the manufacturer assigned to a product to uniquely identify it, for use by systems that specifically require this information. You can use the device’s Modbus map and Modbus commands to read the Modbus Product ID.

The *ION Reference* describes the Factory module in detail. You can download the *ION Reference* and your device’s Modbus map from www.schneider-electric.com.

Troubleshooting

Option module troubleshooting

Your meter's option modules operate sequentially; if one module is non-functional all downstream modules may be affected.

If your meter cannot communicate with an option module, by default it cycles power to that module and all downstream modules, making multiple attempts to communicate. After the maximum number of communication attempts has been exceeded the meter will remove power to that module and all downstream modules.

When troubleshooting option modules, attach each option module directly to the meter and verify its operation. If each option module operates when directly connected, use combinations of modules or known good modules to help identify the issue.

Events related to option module initialization and operation are stored in your meter's onboard event log. Perform an option bus reset to restart the option bus and re-initialize the option modules attached to your meter.

Information about your option module's type, serial number, firmware version and present status is available in the Factory and Diagnostics modules.

See the ION Reference, available from www.schneider-electric.com, for more information about the Factory and Diagnostics modules.

Technical assistance

Visit www.schneider-electric.com for support and assistance technical problems with the meter.

Make sure you include your meter's model, serial number and firmware version in your email or have it readily available if calling Technical Support.

Revenue

Revenue metering overview

A revenue meter provides, over a defined range of operating conditions, measurements that are within international and national defined standards and industry-accepted accuracy limits.

It also provides protection against unauthorized alteration of these measured quantities. National and utility-based standards regulate protection against unauthorized alteration of measured quantities.

Revenue metering components

To meet government regulations and utility security requirements, the meter incorporates three types of security systems:

- traditional anti-tamper mechanical seals on the meter (refer to the installation sheet shipped with your meter)
- password entry to reset meter values, for example, Master reset
- hardware locking mechanism that prevents modification of revenue quantities after they are locked

Revenue firmware security features

Your revenue meter has additional firmware security features:

- You can only upgrade to revenue-qualified firmware and frameworks.
- Your firmware upgrades are recorded in your meter's event log. An additional firmware upgrade log is stored on your meter. Contact Technical Support for information on upgrade log retrieval.
- When revenue-locked, you cannot perform resets, configure some revenue-specific parameters or upgrade your meter.

Protected features and settings

Your revenue meter has features and settings that cannot be changed while revenue-locked.

In order to prevent changes to revenue-related features, settings and meter data, you can apply revenue-locking after all revenue-metering setup is complete. For a complete listing of revenue-locked features and settings, download the ION Device Template Reference, available from www.schneider-electric.com

Revenue locking

Revenue locking may be required to help meet government regulations and utility security requirements.

Revenue locking your meter helps:

- prevent changes to revenue-related features, settings and meter data
- prevent tampering with your meter's voltage and current connections
- ensure the validity of revenue data

Download the ION Device Template Reference, available from www.schneider-electric.com to view a complete listing of revenue-locked features, settings and meter data.

See the meter's catalog pages, available from www.schneider-electric.com, or consult your local Schneider Electric representative for information about your device, its options and accessories.

Related Topics

- Revenue lock LED behavior

Revenue-locking summary

You must configure and revenue lock your meter before installing it.

- Unlock your revenue meter if it is locked.
- Configure the required revenue settings specific for installation.

NOTE: If you are using ION Setup to configure your meter, allow for any communication delays before removing power to your meter.

- Verify the revenue settings have been implemented.
- Clear all accumulated meter data.
- Revenue lock your meter.
- Verify the meter is revenue-locked.
- Install the meter and install the terminal covers according to your meter's installation sheet.

Revenue lock switch

The revenue lock switch located on the meter base is used to revenue lock your meter.

This switch is accessed through a sealable cover.

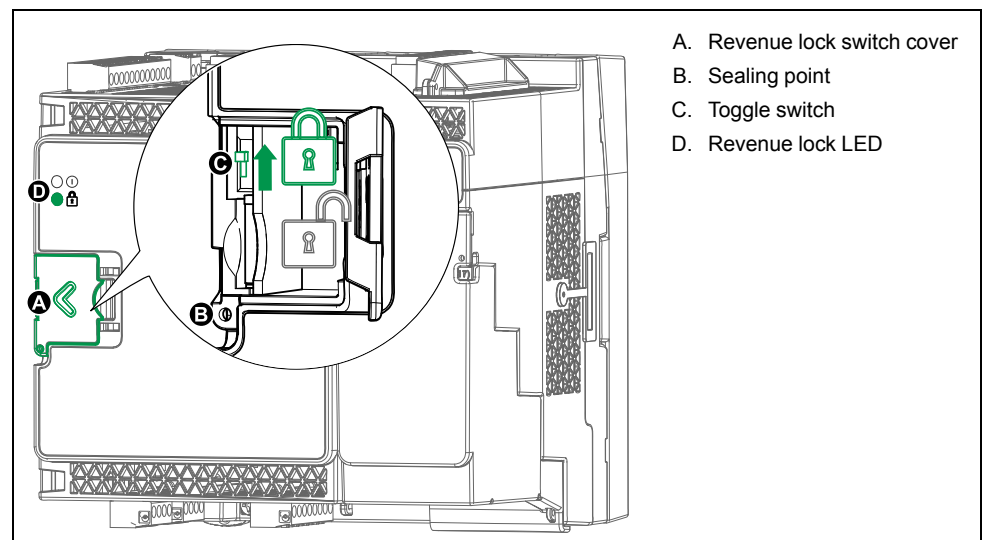

Revenue lock LED behavior

The revenue lock LED indicates the lock status of the meter.

LED behavior	Revenue lock status
Off	The meter is not revenue locked.
On	The meter is revenue locked.
Flashing	New revenue lock state is pending; power cycle your meter to set the revenue lock to on or off.

Revenue locking your meter

You can lock and unlock your meter using the revenue lock switch located on the meter base.

⚠ DANGER

HAZARD OF ELECTRIC SHOCK, EXPLOSION OR ARC FLASH

- Apply appropriate personal protective equipment (PPE) and follow safe electrical work practices. See NFPA 70E in the USA, CSA Z462 or applicable local standards.
- Turn off all power supplying this device and the equipment in which it is installed before working on the device or equipment.
- Always use a properly rated voltage sensing device to confirm that all power is off.

Failure to follow these instructions will result in death or serious injury.

1. Turn off all power supplying this device and the equipment in which it is installed before working on the device or equipment.
2. Always use a properly rated voltage sensing device to confirm that all power is off.
3. Open the revenue lock switch cover.
4. Locate the revenue lock switch.
5. Toggle revenue lock switch on or off.
6. Close the revenue lock switch cover and make sure it is firmly in place.
7. Seal the revenue lock switch cover if required.

Anti-tamper sealing

The meter has several anti-tamper sealing points which can be sealed by a wire seal or lock.

In certain countries, the meter is no longer revenue certified if the anti-tamper seals are broken.

See your meter's installation sheet for sealing point locations.

NOTICE

LOSS OF COMPLIANCE

Ensure that you re-certify your meter with the appropriate revenue metering authorities if you remove the anti-tamper seals.

Failure to follow these instructions may render your device non-compliant for billing purposes.

Revenue lock switch seal

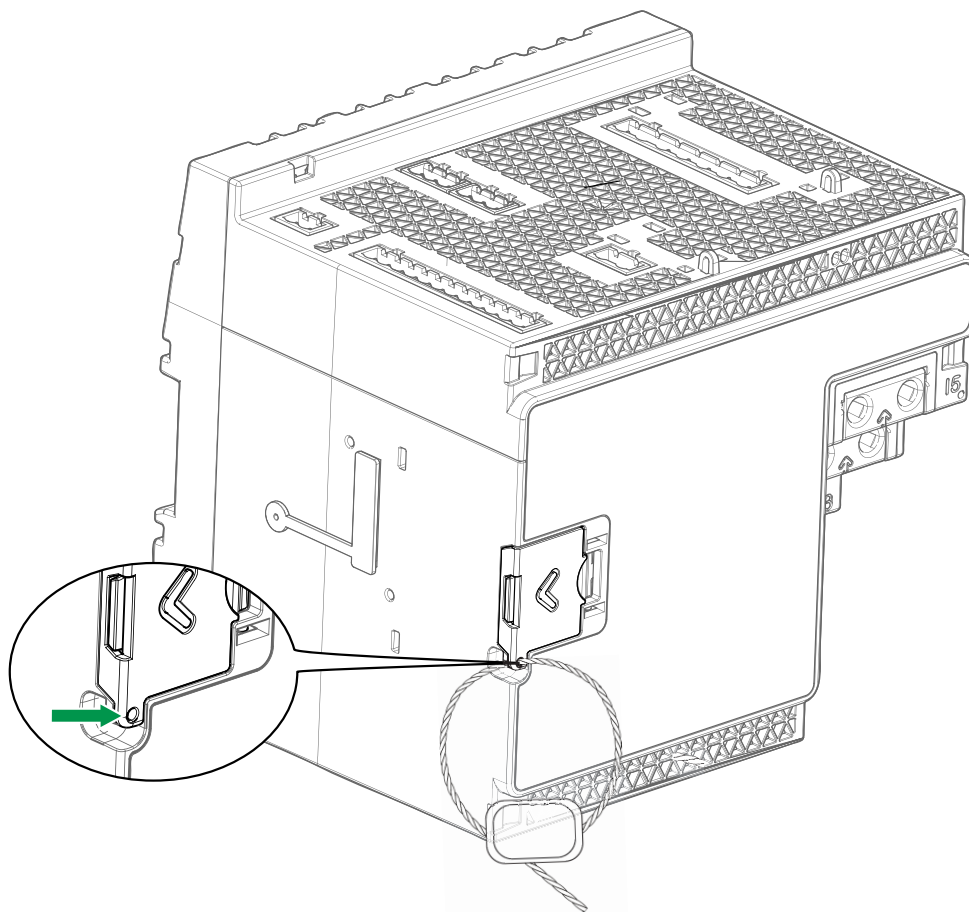

PT/CT correction

Potential transformer / current transformer correction (PT/CT correction), also called instrument transformer correction, can help reduce the need to replace transformers in installations where high accuracy is required.

The primary application for PT/CT correction is to apply correction factors for ratio errors and phase angle errors to instrument transformers. PT/CT correction is done for each current and voltage input to the meter and only affects 1-second power meter data and values derived from it, such as energy or demand. No high-speed, harmonics or waveform values are affected by the correction.

NOTE: For those familiar with ION architecture, the relevant 1-second Power Meter module outputs are compensated using the Instr Xformer (ITC) Correction module. All other modules that use the 1-second Power Meter module's data are also compensated.

See the ION Setup online help, available from www.schneider-electric.com, for instructions on how to configure PT/CT correction on your device.

See the ION Reference, available from www.schneider-electric.com, for detailed information about the Instr Xformer Correction (ITC) module and how it applies PT/CT correction to your device.

Transformer loss compensation

Transformer Loss Compensation (TLC) is the method for compensating for the measurable losses that occur when there is a physical separation between the meter and the actual billing point.

TLC is used when a meter's actual location is different from the electrical location where change of ownership occurs, for example, if meters are connected on the

low-voltage side of power transformers but the ownership change occurs on the high-side of the transformer. Meters are usually installed on the low-voltage side of a transformer because it is more cost-effective

NOTE: Due to the variation in installations, advanced knowledge of power systems and connection methods is required before transformer loss compensation can be properly implemented. Data parameters should only be programmed by qualified personnel that have appropriate training and experience with Transformer Loss Compensation calculations.

There are cases where the change of ownership occurs halfway along a transmission line, where it is impractical to install a meter. In this case, power metering must be compensated using line loss calculations.

See the *Transformer / line loss calculations* technical note available from www.schneider-electric.com.

Time of use

Time of Use (TOU) is often used when a utility has set up schedules with different rates based on time of day, type of day and date when energy is consumed.

You can view the TOU active rates and seasons through your meter's display.

See the ION Setup online help, available from www.schneider-electric.com, for instructions on how to configure time of use on your meter.

See the ION Reference, available from www.schneider-electric.com, for a description of the Time of use module and its settings.

Energy pulsing LED behavior

The visible and infrared LEDs are configured by default to pulse based on energy measured by the meter.

You can configure the pulse weight (pulses per kWh) and the energy source.

Energy pulsing is used to help verify the energy measurement accuracy of your meter for revenue purposes.

Verifying accuracy

Overview of meter accuracy

All meters are tested and verified at the factory in accordance with International Electrotechnical Commission (IEC) and American National Standards Institute (ANSI) standards.

Your digital power meter typically does not require re-calibration. However, in some installations a final accuracy verification of the meters is required, especially if the meters will be used for revenue or billing applications.

Accuracy test requirements

The most common method for testing meter accuracy is to apply test voltages and currents from a stable power source and compare the meter's readings with readings from a reference device or energy standard.

Signal and power source

The meter maintains its accuracy during voltage and current signal source variations but its energy pulsing output needs a stable test signal to help produce accurate test pulses. The meter's energy pulsing mechanism needs approximately 10 seconds to stabilize after every source adjustment.

The meter must be connected to control power in order to conduct accuracy verification testing. Refer to your meter's installation documentation for power supply specifications.

⚠ DANGER

HAZARD OF ELECTRIC SHOCK, EXPLOSION, OR ARC FLASH

Verify the device's power source meets the specifications for your device's power supply.

Failure to follow these instructions will result in death or serious injury.

Control equipment

Control equipment is required for counting and timing the energy pulse outputs from a visible LED, infrared LED or onboard digital output.

- Most standard test benches have an arm equipped with optical sensors to detect LED pulses (the photodiode circuitry converts detected light into a voltage signal).
- The reference device or energy standard typically has digital inputs that can detect and count pulses coming from an external source (i.e., the meter's onboard digital output).

NOTE: The optical sensors on the test bench can be disrupted by strong sources of ambient light (such as camera flashes, florescent tubes, sunlight reflections, floodlights, etc.). This can cause test errors. Use a hood, if necessary, to block out ambient light.

Environment

The meter should be tested at the same temperature as the testing equipment. The ideal temperature is about 23 °C (73 °F). Make sure the meter is warmed up sufficiently before testing.

A warm-up time of 30 minutes is recommended before beginning energy accuracy verification testing. At the factory, the meters are warmed up to their typical operating temperature before calibration to help ensure that the meters will reach their optimal accuracy at operating temperature.

Most high precision electronic equipment requires a warm up time before it reaches its specified performance levels. Energy meter standards allow the manufacturers to specify meter accuracy derating due to ambient temperature changes and self-heating.

Your meter complies with and meets the requirements of these energy metering standards.

For a list of accuracy standards that your meter complies to, contact your local Schneider Electric representative or download the meter brochure from www.schneider-electric.com.

Reference device or energy standard

To help ensure the accuracy of the test, it is recommended that you use a reference device or reference energy standard with a specified accuracy that is 6 to 10 times more accurate than the meter under test. Before you start testing, the reference device or energy standard should be warmed up as recommended by its manufacturer.

NOTE: Reference equipment with a traceable calibration certificate is recommended when performing accuracy testing.

Energy pulsing

Energy pulsing LEDs and digital outputs can be used for energy pulsing.

Your meter is equipped with two types of energy pulsing LEDs: visible light and infrared. These LEDs emit pulses that are then used to determine the accuracy of the meter’s energy measurements. The pulses of light indicate accumulated energy; the meter’s accumulations are compared with the reference/standard’s accumulated energy in order to help determine the meter’s accuracy.

The meter’s digital output can also be used for energy pulsing. A closing (low impedance) and then opening (high impedance) of the digital output represents a pulse. If the accuracy testing equipment has a voltage requirement, a current-limited wetting supply voltage must be provided.

NOTE: Digital outputs on option modules should not be used for meter accuracy testing.

Verifying accuracy test meter settings

Your meter’s power system and other parameters must be configured for accuracy testing.

Meter parameter	Value
Volts mode	4W-Wye (4 wire Wye)
PT/CT correction	Disabled
Test mode	Active NOTE: In test mode, your meter’s billing quantities stop accumulating, and the data is sent to special test mode registers. These registers are cleared when you exit test mode.

Verifying accuracy test

The following tests are guidelines for accuracy testing your meter; your meter shop may have specific testing methods.

⚠ DANGER

HAZARD OF ELECTRIC SHOCK, EXPLOSION, OR ARC FLASH

- Apply appropriate personal protective equipment (PPE) and follow safe electrical work practices. See NFPA 70E in the USA, CSA Z462 or applicable local standards.
- Turn off all power supplying this device and the equipment in which it is installed before working on the device or equipment.
- Always use a properly rated voltage sensing device to confirm that all power is off.
- Do not exceed the device's ratings for maximum limits.
- Verify the device's power source meets the specifications for your device's power supply.

Failure to follow these instructions will result in death or serious injury.

1. Turn off all power supplying this device and the equipment in which it is installed before working on the device or equipment.
2. Use a properly rated voltage sensing device to confirm that all power is off.
3. Connect the test voltage and current source to the reference device or energy standard. Ensure all voltage inputs to the meter under test are connected in parallel and all current inputs are connected in series.

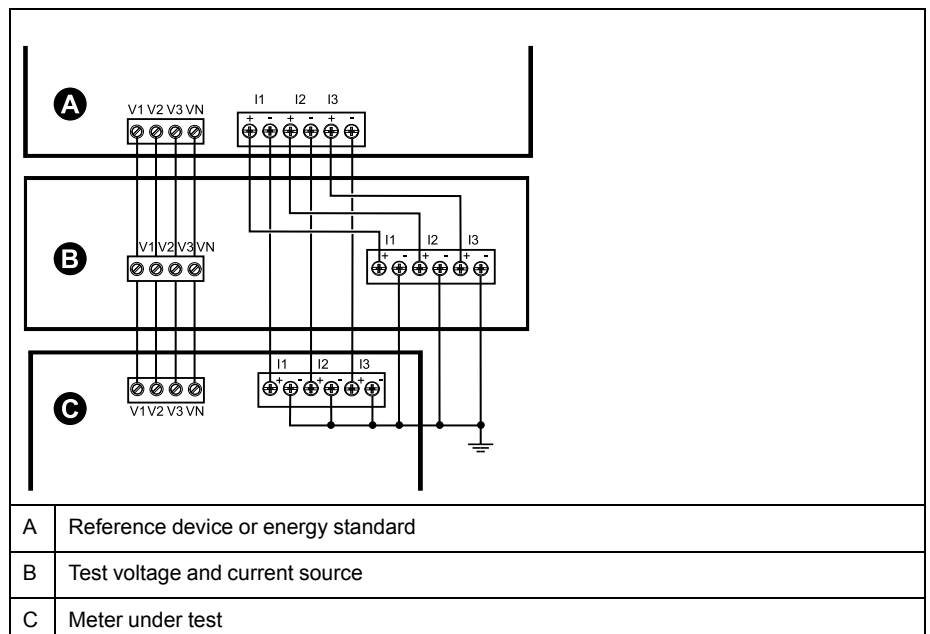

4. Connect the control equipment used for counting the standard output pulses using one of these methods:

Option	Description
Energy pulsing LED	Align the red light sensor on the standard test bench armature over the energy pulsing LED.
Onboard Digital output	Connect the meter's onboard digital output to the standard test bench pulse counting connections.

NOTE: When selecting which method to use, be aware that energy pulsing LEDs and digital outputs have different pulse rate limits.

5. Before performing the verification test, let the test equipment power up the meter and apply voltage for at least 30 seconds. This helps stabilize the internal circuitry of the meter.
6. Configure your meter power settings (such as voltage, current and frequency) to align with the reference device.
7. Depending on the method selected for counting the energy pulses, configure the meter’s energy pulsing LED or one of the digital outputs to perform energy pulsing. Set the meter’s energy pulse constant so it is in sync with the reference test equipment.
8. Perform accuracy verification on the test points. Run each test point for at least 30 seconds to allow the test bench equipment to read an adequate number of pulses. Allow 10 seconds of dwell time between test points.

Calculate the number of required pulses

The reference test equipment typically requires you to specify the number of pulses required for a test duration of “t” seconds.

Normally, the number of pulses required is at least 25 pulses, and the test duration is greater than 30 seconds.

Use the following formula to calculate the required number of pulses:

$\text{Number of pulses} = \frac{N_e * V * I * PF * t}{3600 * K_t}$	
Ne	Number of metering elements used
V	Test point voltage in line-to-neutral volts (V) per phase
I	Test point current in amps (A) per phase
t	Test duration in seconds (s) which must be longer than 30 seconds
PF	Power factor
Kt	Pulse constant programmed in the meter under test in Wh/pulse

Round up the result of the calculation to the nearest integer number of pulses.

Calculation for number of required pulses

This example calculates the number of pulses required for an inductive load 3-phase test point with a test duration of 60s; the source is configured to use V = 120V, I = 5A, PF = -0.5; the pulse constant of the meter under test is Kt = 1.8 Wh/pulse.

$$8.3 = \frac{3 * 120 \text{ V} * 5 \text{ A} * .5 * 60 \text{ s}}{3600 * 1.8}$$

Round the number up to the nearest integer: Number of pulses = 9

Percentage error calculation for accuracy verification testing

Accuracy verification testing requires you to calculate the percentage error between the meter being tested and the reference/standard.

Calculate the percentage error for every test point using the following formula:

$$\text{Energy error} = (EM - ES) / ES * 100\%$$

Where:

- EM = energy measured by the meter under test
- ES = energy measured by the reference device or energy standard.

NOTE: If accuracy verification reveals inaccuracies in your meter, they may be caused by typical sources of test errors. If there are no sources of test errors present, please contact your local Schneider Electric representative.

Typical sources of test errors

If you see excessive errors during accuracy testing, examine your test setup and test procedures to eliminate typical sources of measurement errors.

Typical sources of accuracy verification testing errors include:

- Loose connections of voltage or current circuits, often caused by worn-out contacts or terminals. Inspect terminals of test equipment, cables, test harness and the meter under test.
- Meter ambient temperature is significantly different than 23 °C (73 °F).
- Floating (ungrounded) neutral voltage terminal in any configuration with unbalanced phase voltages.
- Inadequate meter control power, resulting in the meter resetting during the test procedure.
- Ambient light interference or sensitivity issues with the optical sensor.
- Unstable power source causing energy pulsing fluctuations.
- Incorrect test setup: not all phases connected to the reference device or the energy standard. All phases connected to the meter under test should also be connected to the reference meter/standard.
- Moisture (condensing humidity), debris or pollution present in the meter under test.

Accuracy verification test points

The meter should be tested at full and light loads and at lagging (inductive) power factors to help ensure testing over the entire range of the meter.

The test amperage and voltage input rating are labeled on the meter. Refer to the installation sheet or data sheet for your meter’s nominal current, voltage and frequency specifications.

Watt-hour test point	Sample accuracy verification test point
Full load	100% to 200% of the nominal current, 100% of the nominal voltage and nominal frequency at unity power factor or one (1).
Light load	10% of the nominal current, 100% of the nominal voltage and nominal frequency at unity power factor or one (1).
Inductive load (lagging power factor)	100% of the nominal current, 100% of the nominal voltage and nominal frequency at 0.50 lagging power factor (current lagging voltage by 60° phase angle).

VAR-hour test point	Sample accuracy verification test point
Full load	100% to 200% of the nominal current, 100% of the nominal voltage and nominal frequency at zero power factor (current lagging voltage by 90° phase angle).
Light load	10% of the nominal current, 100% of the nominal voltage and nominal frequency at zero power factor (current lagging voltage by 90° phase angle).
Inductive load (lagging power factor)	100% of the nominal current, 100% of the nominal voltage and nominal frequency at 0.87 lagging power factor (current lagging voltage by 30° phase angle).

Specifications

Specifications overview

This section provides additional specifications for your meter and accessories.

The information contained in this section is subject to change without notice. You can download updated documentation from www.schneider-electric.com or contact your local Schneider Electric Industry representative for the latest updates.

See your device's installation sheet for specifications related to installation, such as measured current and voltage ranges, inputs/outputs and control power information.

Mechanical characteristics

ION9000 series meter

Mounting options	DIN rail: IEC 60715 (DIN EN 60715), TH 35–7.5 or TH 35–15 Panel mount: with 9B2BMA
Orientation	Vertical, retaining clips located on bottom of meter
IP degree of protection	IP30 (except connectors)
Maximum number of option modules	4 (based on maximum operating temperature)

Mechanical compliance

Vibration	IEC 60068-2-6 IEC 60068-2-57
Shock	IEC 60068-2-27 IEC 60068-2-31, Test Ec Free fall procedure 1

Electrical characteristics

Measurement accuracy

Active energy (Wh)	IEC 62053-22 Class 0.1 S
Reactive energy (VARh)	IEC 62053-24 Class 0.5 S
Power monitoring device (PMD)	IEC 61557-12 PMD/SD/K70/0.2 and PMD/SS/K70/0.2
Active power (P)	IEC 61557-12 Class 0.1
Reactive power (Q_V)	IEC 61557-12 Class 1
Apparent power (S_V)	IEC 61557-12 Class 0.2
Apparent energy (E_{apV})	IEC 61557-12 Class 0.2
Current (I)	IEC 61557-12 Class 0.1
Voltage (U)	IEC 61557-12 Class 0.1
Frequency (f)	IEC 61557-12 Class 0.02

NOTE: Reactive energy and demand values, by default, are based only on the fundamental frequency, and do not include higher harmonics. Active and apparent energy and demand values are measured using the entire signal including harmonics. Contact Technical Support for more information.

Power quality

Power quality instrument (PQI)	IEC 62586-1/2 PQI-A IEC 61000-4-30 Class A ($U_{din} = 230\text{ V}$) IEC 61000-4-15 Class F1 ($U_{din} = 230\text{ V} / 50\text{ Hz}, 120\text{ V} / 60\text{ Hz}$)
Voltage unbalance (U_{nb})	IEC 61557-12 Class 0.2
Voltage harmonics (U_h)	IEC 61557-12 Class 1
Voltage THD (THD_u)	IEC 61557-12 Class 1
Current harmonics (I_h)	IEC 61557-12 Class 1
Current THD (THD_i)	IEC 61557-12 Class 1
Waveform capture	16 - 1024 cycles per sample

Voltage inputs

Specified accuracy range	57 to 400 V L-N / 100 to 690 V L-L (Wye) or 100 to 600 V L-L (Delta or Wye with unearthed neutral)
Specified accuracy frequency	50/60 Hz $\pm 15\%$, 400 Hz $\pm 10\%$
Overload	600 V L-N or 1035 V L-L
Impedance	> 5 M Ω
Measurement category	III

Current inputs

Nominal	IEC: 1A / 5A (Class 0.1 S) ANSI: Current Class 2, 10, 20 (Accuracy Class 0.1)
Specified accuracy current range	10 mA – 20 A
Starting current	1 mA
Withstand	30 A continuous, 50 A @ 10 sec/hr, 500 A @ 1 sec/hr
Impedance	0.3 m Ω (typical)
Burden	0.01 VA max at 5 A

Control power

AC control power	
Operating range	50/60 Hz $\pm 10\%$: 90 to 480 V $\pm 10\%$ 400 Hz: 90 to 120 V $\pm 10\%$
Burden (meter only)	max: 16.5 W / 38 VA @ 480 V (45 – 65 Hz) max: 13 W / 24 VA @ 120 V (400 Hz)
Burden (fully optioned meter)	max: 40 W / 80 VA @ 480 V (45 – 65 Hz) max: 36 W / 58 VA @ 120 V (400 Hz)
Ride-through time (no optional accessories)	100 ms (6 cycles at 60 Hz) typ., 120 V AC 400 ms (24 cycles at 60 Hz) typ., 240 V AC 1200 ms (72 cycles at 60 Hz) typ., 480 V AC
DC control power	
Operating range	110 to 480 V DC $\pm 15\%$
Burden (meter only)	max. 13.5 W at 480 V DC
Burden (fully optioned meter)	37 W at 480 V DC
Overvoltage category	III

Digital output (Form A)

Number	4
Type	Form A solid-state
Reference voltage	40 V
Maximum load voltage	30 V AC / 60 V DC
Maximum load current	75 mA
ON resistance	13 – 40 Ω at 25 °C (77 °F)
Signal type	Continuous or pulse
Pulse frequency	≤ 25 Hz

Relay output (Form C)

Number	2
Type	Form C mechanical relay
Maximum load voltage	250 V AC / 30 V DC
Maximum load current	8 A @ 250 V AC 5 A @ 24 V DC 20k cycles (resistive)
Operate time	max: 10 ms
Release time	max: 5 ms
Lifetime	No Load: 10,000,000 operations Rated Voltage and Load: 50,000 operations

Digital inputs

Number	8
Type	Externally excited, 24 V DC wetting voltage available from the meter
Reference Voltage	40 V
Event timestamp accuracy	± 1 ms
Maximum voltage	30 V AC / 60 V DC
Pulse frequency	≤ 25 Hz
Response time	1 cycle
Minimum pulse width	20 ms
Current draw	ON: ≤ 2.5 mA OFF: ≤ 0.5 mA
Voltage ON state	4 to 30 V AC / 4 to 60 V DC
Voltage OFF state	0 to 1.4 V AC / 0 to 2.0 V DC
IRIG-B	IRIG-B00x format (unmodulated IRIG-B time code) Coded expressions 0 to 7 are supported but the year data is not used.

Environmental characteristics

Operating temperature	-25 °C to 70 °C (-13 °F to 158 °F) NOTE: Maximum operating temperature could change based on the quantity and type of attached option modules. See <i>Maximum operating temperature with option modules, page 217</i> .
Storage temperature	-40 °C to 85 °C (-40 °F to 185 °F)
Humidity rating	5% – 95% RH non-condensing Maximum dewpoint: 37 °C (99 °F)

Pollution degree	2
Altitude	< 3000 m (9843 ft) above sea level
Location/mounting	Not suitable for wet locations For indoor use only Must be permanently connected and fixed

Maximum operating temperature with option modules

Maximum operating temperature	PM89M2600 Digital (2 out, 6 in)	PM89M0024 Analog (2 out, 4 in)
70 °C (158 °F)	0 - 4	0,1
70 °C (158 °F)	0	2
60 °C (140 °F)	1, 2	2 - 4

LEDs

Energy pulsing LEDs (visible and infrared)

Type	Visible orange, infrared
Wavelength	600 – 609 nm (orange), 825 – 925 nm (infrared)
Maximum pulse rate	10 Hz (100 ms)

Status LEDs (visible)

Type	Bi-color, red/green
------	---------------------

EMC (electromagnetic compatibility)

EMC standards	IEC 62052-11, IEC 61326-1, IEC 61000-6-5
Immunity to electrostatic discharge	IEC 61000-4-2
Immunity to radiated fields	IEC 61000-4-3
Immunity to fast transients	IEC 61000-4-4
Immunity to surges	IEC 61000-4-5
Immunity to conducted disturbances	IEC 61000-4-6, IEC 61000-4-16
Immunity to power frequency magnetic fields	IEC 61000-4-8
Immunity to conducted disturbances, 2 - 150 kHz	CLC/TR 50579
Immunity to voltage dips and interruptions	IEC 61000-4-11
Immunity to ring waves	IEC 61000-4-12
Conducted and radiated emissions	EN 55011 and EN 55032 Class B, FCC part 15 Class B, ICES-003 Class B
Surge withstand capability (SWC)	IEEE/ANSI C37.90.1

Safety

Safety construction	IEC/EN 61010-1, CAT III, 400 VLN / 690 V LL UL 61010-1 and CSA-C22.2 No. 61010-1, CATIII, 347 V LN / 600 V LL IEC/EN 62052-31, Protective Class II
---------------------	--

Ethernet communications

Number of ports	2 (switched mode)
Maximum cable length	100 m (328 ft), per TIA/EIA 568-5-A
Cable type	CAT5 (or higher)
Connector type	Unshielded RJ45 modular connector (2)
Mode	10Base-T, 100Base-TX, Auto-MDIX
Data rate	up to 100 Mbps

RS-485 communications

Number of ports	2
Cable type	Shielded twisted pair
Maximum cable length	1200 m (4000 ft)
Maximum number of devices (unit loads)	Up to 32 devices on the same bus
Parity	None, even, odd
Baud rate	2400 – 115200, 19200 recommended

Real-time clock

Clock drift (time error)	Meter Powered ON: 5 ppm max Meter Powered OFF: 20 ppm max at 25 °C (77 °F)
Battery backup time	Minimum 7 years under specified storage conditions

Display

METSERD192 display

Display	
Display type	Capacitive touchscreen, WVGA color graphic TFT LCD 800 x 480 resolution
Display backlight	White LED
Viewable area	152.5 x 91.5 mm (6.00 x 3.60 in)
Weight	0.9 kg (2.0 lb)
Communications ports	
Optical communications ports	ANSI C12.18 optical port IEC 1107 optical port adapter
USB communications ports	USB host port: Type A USB USB device port: Mini-B USB
Control power	
Power over Ethernet (PoE) power	PD Type 1 Class 3 per IEEE 802.3af, 10W max.
Auxiliary control power (Not required for PoE applications)	24 V DC ± 20% DC burden 10 W max. Use UL listed or UL recognized NEC class 2 (or equivalent SELV or PELV) power source
Communication connection	
Cable type	CAT5 (or higher). Use with unshielded RJ45 modular connector
Cable length	100 m (330 ft) max.
Connection type	Direct, point-to-point

Environment	
Operating temperature	-20 °C to 60 °C (-4 °F to 140 °F)
Storage temperature	-40 °C to 85 °C (-40 °F to 185 °F)
Humidity rating	5% – 95% RH non-condensing Maximum dewpoint: 37 °C (99 °F)
Pollution degree	2
Altitude	< 3000 m (9843 ft) above sea level
IP degree of protection	Front: IP65 Rear: IP30
Location/mounting	For UL Type 12 applications, install display on a flat surface of a Type 12 enclosure Not suitable for wet locations For indoor use only

METSEPM89RD96 display

Display	
Display type	1/4 VGA color graphic TFT LCD 320 x 240 resolution
Display backlight	White LED
Keypad	5 button
Viewable area	70.6 x 52.9 mm (2.78 x 2.08 in)
Communication connection	
Cable type	CAT5 (or higher). Use with unshielded RJ45 modular connector
Cable length	100 m (330 ft) max.
Connection type	Direct, point-to-point
Environment	
IP degree of protection	Front: IP54 Rear: IP30

Option modules

See your option module's installation sheet for additional option module specifications.

METSEPM89M0024 Analog (2 out, 4 in)

Maximum number of modules	4
Input resistance	< 300 Ω (current mode) > 500 kΩ (voltage mode)
Max analog input current/voltage	20 mA / 30 V DC
Maximum meter operating temperature	-25 °C to Max temp (-13 °F to Max temp) Maximum operation temperature is based on the quantity and type of attached option modules. See <i>Maximum operating temperature with option modules, page 217</i> .

METSEPM89M2600 Digital (2 out, 4 in)

Maximum number of modules	4
Maximum meter operating temperature	-25 °C to Max temp (-13 °F to Max temp) Maximum operation temperature is based on the quantity and type of attached option modules. See <i>Maximum operating temperature with option modules, page 217</i> .

Other

Parameter	Description
Weight (meter only)	1.5 kg (3.3 lb)
Meter start time ¹	20 seconds: Measurements and serial communications 30 seconds: Ethernet communications 45 seconds: Display initialization
Meter memory	2000 MB
Data update rate	Regular data: 1 second High-speed: 50 – 60 Hz half-cycle
Advanced security user accounts	Up to 50 users

¹ Meter start up time is expressed as the elapsed time from the application of control power to the result indicated in the description field.

Printed in.
Schneider Electric
35 rue Joseph Monier
92500 Rueil Malmaison – France
+ 33 (0) 1 41 29 70 00

Schneider Electric
35 rue Joseph Monier
92500 Rueil Malmaison
France

+ 33 (0) 1 41 29 70 00

www.schneider-electric.com

As standards, specifications, and design change from time to time,
please ask for confirmation of the information given in this publication.

© 2018 – Schneider Electric. All rights reserved.

7EN02-0390-00